Fleetguard®



Hydraulic Filters

LT36499



Introduction.....	9-3
HF6500 Series	9-9
HF6600 Series	9-15
HF6700 Series	9-21
HF6800 Series	9-31
Dual Spin-On Assembly.....	9-35
Discontinued Parts	9-39
Revisions	9-43

Cummins Filtration® offers an extensive line of Fleetguard® mobile and industrial hydraulic filter replacements for competitors such as Donaldson®, Fairey Arlon, Hycon, Pall, Parker Hannifin, Schroeder, and Vickers®. Every hydraulic element is designed and manufactured to the highest standard of quality and meets or exceeds global OEM specifications. You can expect high system performance, design flexibility and product quality to meet your needs.

Proper oil cleanliness levels are critical clearances on components in the hydraulic fluid stream. In our state-of-the-art testing facilities, Cummins Filtration performs multi-pass, pressure-drop, flow-fatigue, and hydrostatic burst testing on all hydraulic elements to ensure product reliability and top performance.

We offer many choices of filtration media and micron rating efficiencies. Our high performance synthetic products can replace cellulose elements and provide up to 100 times the filtration of fine particles without sacrificing any dirt-holding capacity. The numerous benefits of these products include longer component life that reduces operating expenses and maintenance hassles. Hydraulic filter elements are also available for petroleum-base and water-base fluid compatibility, and filter heads come in multiple inlet and outlet port sizes and with various by-pass valve settings to meet specific requirements.

Depending on the model, Fleetguard hydraulic filter systems include the following capabilities from the HF6500 through to the HF6800 Series :

- Rated flows range: 37 gal/min (140 L/min) to 55 gal/min (208 L/min)
- Maximum static pressures range: 350 lb/in² (2413 kPa) to 700 lb/in² (4826 kPa)
- Recommended working pressures: 250 lb/in² (1724 kPa) to 400 lb/in² (2758 kPa)

Our extensive line of replacement hydraulic filters for spin-on applications meets the following specifications:

- Rated Fatigue Strength (NFPA Standard T2.6.1, ISO 10771-1) 1,000,000 cycles @ 0-350 PSID (0-2413.2 kPa); 300,000 cycles @ 0-400 PSID (0-2757.9 kPa); 100,000 cycles @ 0-500 PSID (0-3447.4).
- Rated Static Pressure (NFPA Standard T2.6.1); 1,000 PSID (6894.8 kPa)
- Element Collapse Pressure Rating (ISO 2941)

Depend on Cummins Filtration to meet all your hydraulic and transmission system needs with the best products that deliver the highest performance and greatest reliability.

Introduction

The following description of Cummins Filtration® specifications for Fleetguard filters allows you to be certain that you select the correct filter to meet your hydraulic system needs.

Filtration Efficiency

ISO (International Organization for Standardization), NFPA (National Fluid Power Association) and ANSI (American National Standards Institute) use beta ratio to qualify the filtration efficiency of filters. The standard for evaluating filter contaminant holding capacity and filtration efficiency is ISO 16889-1999, “Hydraulic Fluid Power Filters – Multi-pass Method for Evaluating Filtration Performance of a Filter Element.” It is based on the ISO 11171-1999 particle count calibration method which uses $\mu\text{m(c)}$ as the standard unit. The previous standard, ISO 4572-1981, was based on the ISO 4402-1991 particle count calibration method which used μm as the standard unit. For example, 2 μm , 5 μm , 10 μm , and 15 μm become (approximately) 4 $\mu\text{m(c)}$, 6 $\mu\text{m(c)}$, 10 $\mu\text{m(c)}$, and 15 $\mu\text{m(c)}$, respectively under the new standard. For more information on the change from ISO 4572-1981 to ISO 16889-1999 and the change from μm to $\mu\text{m(c)}$ units, see ISO TR16186-1999.

The Beta ratio ($\bar{\beta}$) is determined by counting the number of particles over a given size upstream of the filter and dividing that number by the number of particles over the given size down stream of the filter.

Example: If a filter has 1000 particles 10 microns and larger upstream and 50 particles down stream, the β is 20.

$$\beta_{10} = \frac{1000 \text{ Particles Upstream}}{50 \text{ Particles Downstream}} = 20$$

Efficiency is calculated using the formula below, the table shows the efficiencies.

$$\text{Efficiency} = 100 - \left(\frac{100}{\beta} \right)$$

$\beta_{5(c)}$	2	5	10	20	30	50	75	100	200	1000
Efficiency %	50	80	90	95	96.67	98	98.67	99	99.5	99.9

The β for a given media varies somewhat as the filter is used and becomes plugged with contaminant. Due to this variation in the β , Cummins Filtration uses a time-weighted average β .

Flow Versus Differential Pressure

All flow versus differential pressure data contained in this catalog is based on using 32 mm^2/s hydraulic fluid in a clean filter assembly.

For element ΔP at viscosity other than shown:

$$\Delta P = (\Delta P \text{ from graph}) \times \left(\frac{\text{New Viscosity in } \text{mm}^2/\text{s}}{32 \text{ mm}^2/\text{s}} \right) \times \left(\frac{\text{New Specific Gravity}}{0.9} \right)$$

Rated Static Pressure (per ANSI/NFPA T2.6.1)

Rated static pressure indicates the minimum pressure at which leakage of the filter will occur using Fleetguard heads.

Recommended Maximum Operating Pressure (Non-Shock)

Cummins Filtration determines safe operating pressure for non-shock systems. All operating pressures indicated in this catalog were obtained using Fleetguard heads. We recommend that you contact Cummins Filtration Technical Assistance with any questions regarding safe operating conditions.

Fabrication Integrity (per ISO 2942)

Fleetguard Hydraulic filters are tested in accordance with ISO 2942, which is a test to verify the fabrication integrity and to determine the first bubble point occurrence.

1. Select the particle size and media from the chart on the following page.
2. Select the working pressure of the filter element.
3. Select the maximum flow rating of the system in gallons per minute.
4. When selecting a filter to match the flow rate, try to choose a filter that has your desired flow at 2-8 PSID (13.8-55.2 kPa) clean pressure drop. This will give you a more satisfactory life than a filter with higher flows and higher clean pressure drops. Avoid selecting a filter that will have a clean pressure drop in excess of 9 PSID (62.1 kPa). Short filter life may be the result. See the flow charts with each filter series.

Choice of Filter Heads is Dependent Upon the Filter Selected

1. Select the filter head from the tables that accompany the filter series that you select. Use only heads that accompany those filters.
2. Select the head by-pass valve option, see “By-Pass Valve Options” below.
3. Select the port-size thread options.

By-Pass Valve Options

The head by-pass valve options available are: NONE, 4 PSID (27.6 kPa), 25 PSID (172.4 kPa), and 44 PSID (303.4 kPa).

It is recommended that you use a 4 PSID (27.6 kPa) head in applications where the head/filter combination will be used as a suction (pump inlet) filter.

In applications where the by-pass valve option is NONE, the head should be used with a differential pressure gauge to determine when to service the filter.

CAUTION: Failure to use a differential pressure gauge where the by-pass valve option is NONE will result in an element collapse or burst when the element becomes fully plugged.

Locations are available to drill and tap the heads for these gauges (not all heads have this option). Gauges are not supplied by Cummins Filtration®.

For most applications, heads with 25 PSID (172.4 kPa) by-pass valves will be satisfactory. Gauge ports can be drilled and tapped. Electric indicators preset for 15 PSID (103.4 kPa) are offered. Indicators will trigger when the filter element is 90-95% plugged. Filters should be serviced at this time.

For our HF6800 series heads and filters, 44 PSID (303.4 kPa) by-pass valves are standard. Electric indicators preset at 28 PSID (193.1 kPa) are optional and can be ordered separately (part number HH6978). Indicators will trigger when the filter element is 90-95% plugged. Filters should be serviced at this time.

Port sizes are given in the size of the threads, not the internal line size.

Introduction

How to Use the Media/ISO Chart

The numbers with slashes (“/”) at the top of each bar in the chart represent the ISO Solid Contamination Code. The first number is an indication of the number of contaminant particles that are 4 micron(c) and larger that can be contained in a volume of hydraulic fluid. The second number indicates the number of contaminant particles that are 6 micron(c) and larger that can be contained in the same volume. The third number indicates the number of contaminant particles that are 14 micron(c) and larger that can be contained in the same volume. The code looks like this: “20/18/14.” The smaller these three numbers, the cleaner the hydraulic system and/or the more demanding the system is for cleanliness. Component manufacturers specify the desired ISO code for the component parts and systems they build. To select the most suitable media, determine the ISO code for the MOST SENSITIVE component part(s) as specified by the component manufacturer. If the ISO code is in the range of 15/13/9 to 21/19/15, select a Synthetic Media (a high pressure synthetic media which, given identical efficiency performance, possesses lower restriction and higher capacity characteristics) by reading the “x=?” underneath the bar that represents the ISO code. A suitable ISO code (and media) can be determined by knowing the Maximum System Pressure and the Sensitivity Range of the system. Consult the Hydraulic Component Categories to determine the system’s sensitivity based on application. For example, if the target pressure is 3000 lb/in² and the application is “Construction Equipment,” the ISO code is 17/15/11 and the media is x=7. Then select a filter that has Synthetic Media rated at $\beta_{7(c)}=75$.

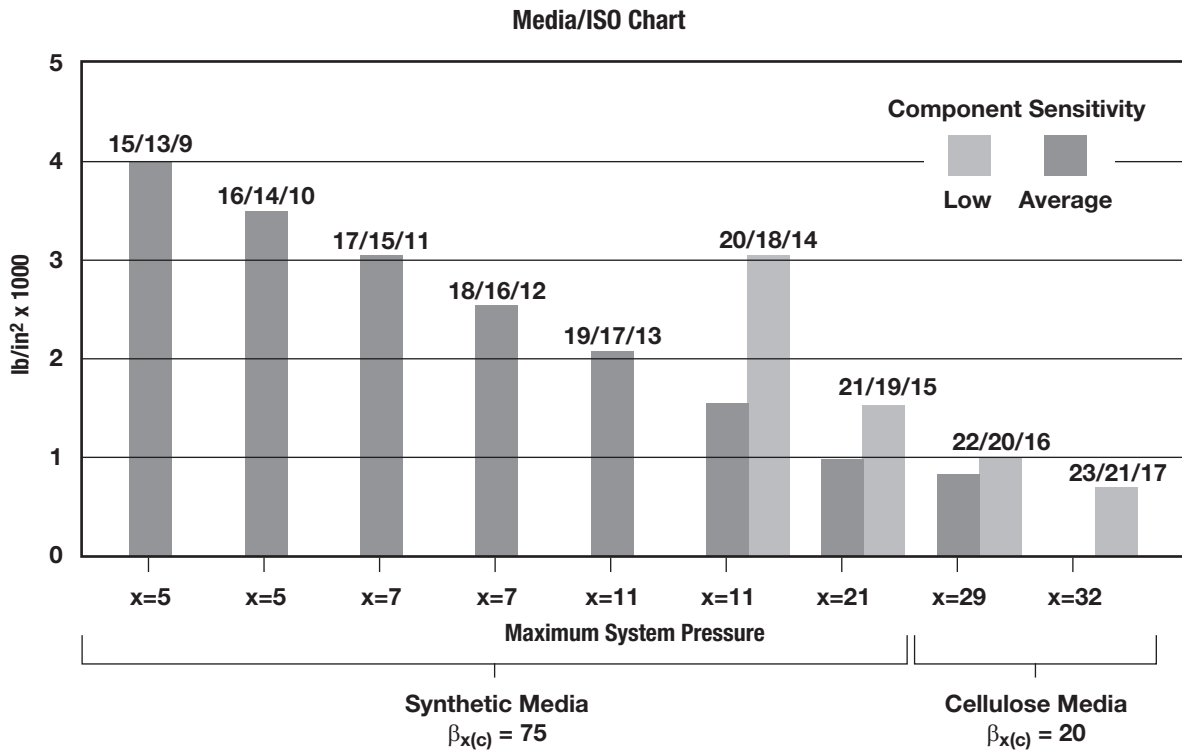

Hydraulic Component Categories

Low	Average	High
<ul style="list-style-type: none"> Low Pressure Industrial Machines Large Clearances Older Hydraulic Machinery Small Tractor Hystat Least Silt Sensitive 	<ul style="list-style-type: none"> Automotive Manufacturing Mining Equipment Construction Equipment Paper Mills Machine Tools Less Silt Sensitive 	<ul style="list-style-type: none"> Aerospace Robotics Laboratory Aircraft Machine Tools Servo Controls Very Silt Sensitive

The two primary hydraulic fluid types are mineral based and fire retardant. Mineral based (or petroleum based) fluids represent the most commonly used hydraulic fluid type. Fire retardant fluid types include water glycols, water in oil emulsions, high water based fluids (HWBF) and phosphate esters. Filter compatibility with specific fluid types is determined by component material type. The chart below summarizes fluid compatibility and component material relationships. For most fluids, more than one compatible component material option exists. For seal options, the most economically optimum material for most fluids is Buna N.

Fluid	Seal Material	Media
Petroleum	Buna N Fluorocarbon	Synthetic Cellulose*
Water Glycol	Buna N Fluorocarbon Ethylene Propylene Rubber	Synthetic Cellulose*
Water in Oil Emulsion	Buna N Fluorocarbon	Synthetic Cellulose*
HWBF	Buna N Fluorocarbon	Synthetic Cellulose*
Industrial Phosphate Ester (ARYL)	Fluorocarbon Ethylene Propylene Rubber	Synthetic

* It is recommended to use Synthetic media with water-based fluids. Unsuitable cellulose grades will tend to disintegrate in application.

HF6500 Series

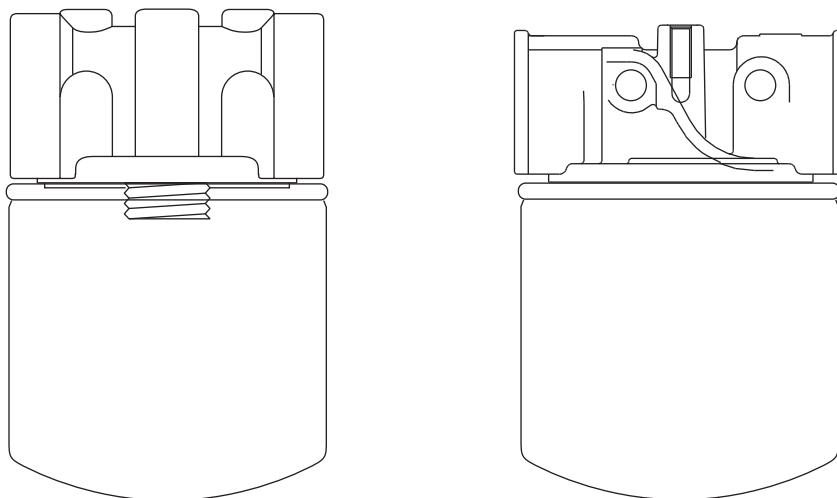

Specification	HF6500 Series – Style A	HF6500 Series – Style B
Rated Flow	Up to 37 gal/min (140 L/min)	See Ordering Information
Maximum Static Pressure	350 lb/in ² (2413 kPa)	260 lb/in ² (1800 kPa)
Recommended Working Pressure (Non-shock operating conditions)	250 lb/in ² (1724 kPa)	175 lb/in ² (1200 kPa)
Seals	Buna N	Buna N
Filter Service Clearance	Min. 0.64" (1.63 mm)	Min. 0.64" (1.63 mm)

Note: lb/in² is the standard SI notation for psi.
Specifications subject to change without notice.

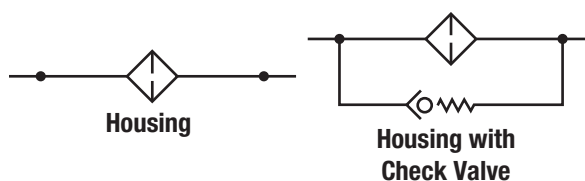

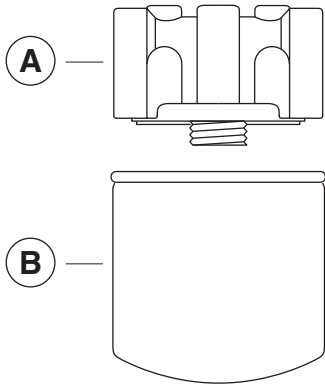

Part	Description	Part Number
A	Filter Head	See Ordering Information
B	Filter Element	See Ordering Information

Filter Head Part Number	Fluid In & Out Port Size	By-Pass Setting PSID (kPa)	Indicator Type*
HH6943	3/4" NPTF	None	None
HH6944		4 (27.6)	None
HH6945		25 (172.4)	None
HH6946	1" NPTF	None	None
HH6947		4 (27.6)	None
HH6948		25 (172.4)	None

*Can be drilled and tapped for pressure and/or vacuum gauges.

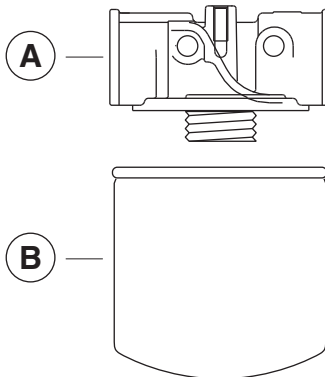

Part	Description	Part Number
A	Filter Head	See Ordering Information
B	Filter Element	See Ordering Information
	Clogging Indicator (not shown)	See Ordering Information

Filter Head Part Number	Fluid In & Out Port Size	By-Pass Setting PSID (kPa)	Rated Flow gal/min (L/min)	Application*
ST1024HH	3/4" BSP	3.6 (25)	6.6 (25)	Suction Line
ST1025HH		25.4 (175)	23.7 (90)	Return Line

* Units are pre-drilled with 1/8" BSP tapings for the installation of pressure and/or vacuum gauges. See ordering information below.

Part Number	Description
ST1398MR	Pressure gauge for return line application

Part Number	b _{x(c)} > 200	b _{x(c)} > 75	b _{x(c)} > 2	Media	Element Length in (mm)	Fluid Compatibility
Style A						
HF6500	N/A	11	4	Cellulose/Synthetic	5.68 (144.27)	Petroleum Base
HF6510	38	47	14	Cellulose	5.68 (144.27)	Petroleum Base
HF6511	38	47	14	Cellulose	8.00 (203.20)	Petroleum Base
HF6520	N/A	29	13	Cellulose/Synthetic	5.68 (144.27)	Petroleum Base
HF6521	N/A	29	13	Cellulose/Synthetic	8.00 (203.20)	Petroleum Base
HF6522	–	140	–	Wire Mesh	5.68 (144.27)	Petroleum and Water Base
HF6523	–	140	–	Wire Mesh	8.00 (203.20)	Petroleum and Water Base
Style B						
HF6535	–	14	5	Cellulose	5.78 (147)	Petroleum Base
HF6536	–	14	5	Cellulose	8.07 (205)	Petroleum Base
HF6537	–	23	11	Cellulose	5.78 (147)	Petroleum Base
HF6538	–	23	11	Cellulose	8.07 (205)	Petroleum Base
HF6539	6	5	–	Synthetic	5.78 (147)	Petroleum and Water Base
HF6541	12	10	6	Synthetic	5.78 (147)	Petroleum and Water Base
HF6542	12	10	5	Synthetic	8.07 (205)	Petroleum and Water Base
HF6544	27	23	10	Synthetic	8.07 (205)	Petroleum and Water Base
HF6591	27	23	10	Synthetic	5.78 (147)	Petroleum and Water Base
ST1813	–	90	–	Wire Mesh	5.78 (147)	Petroleum and Water Base

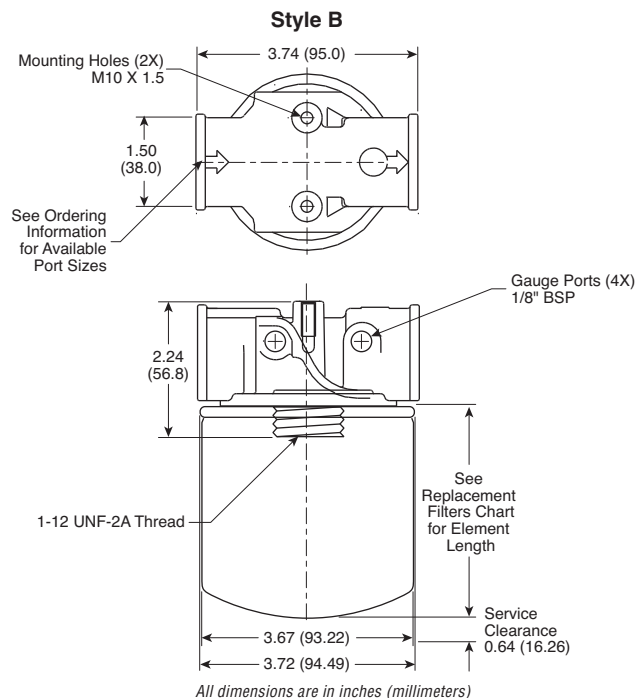
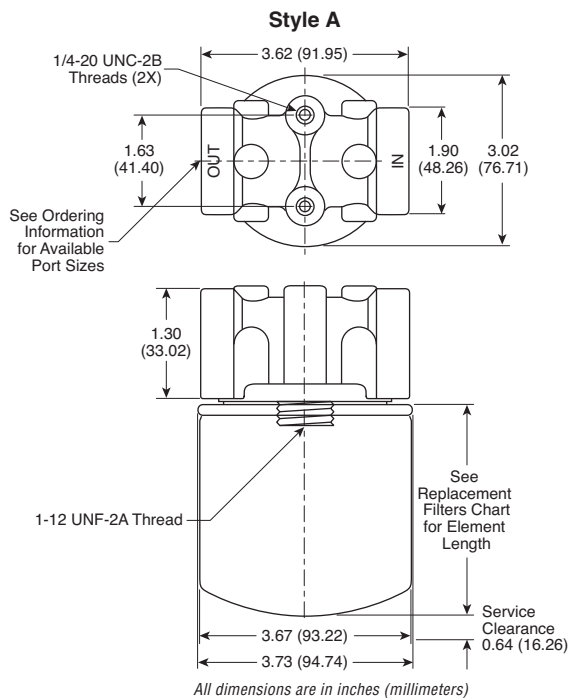

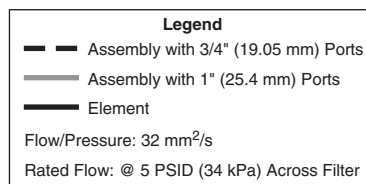
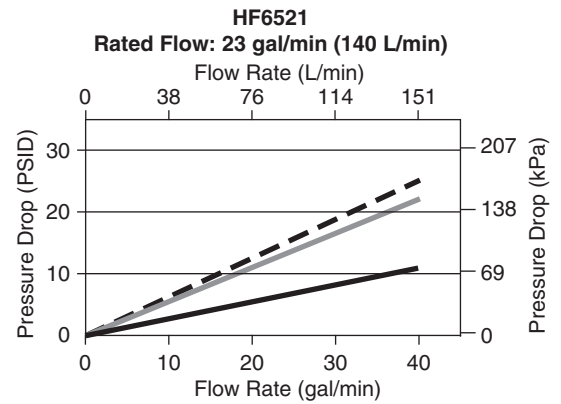
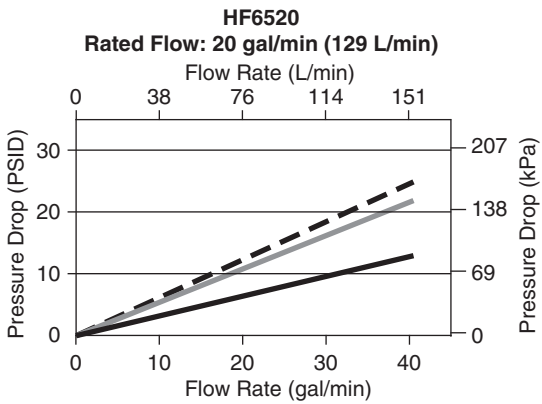
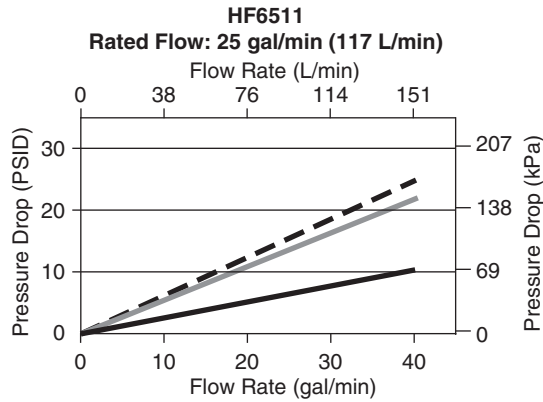
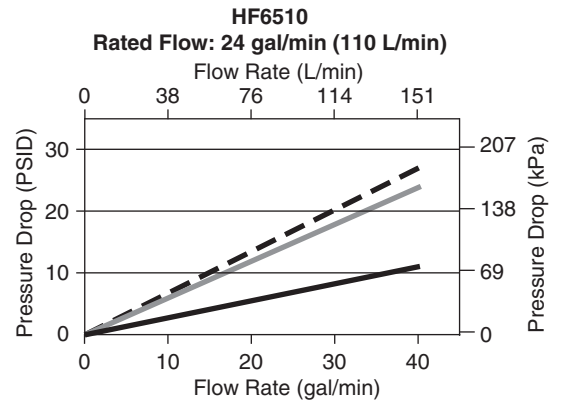
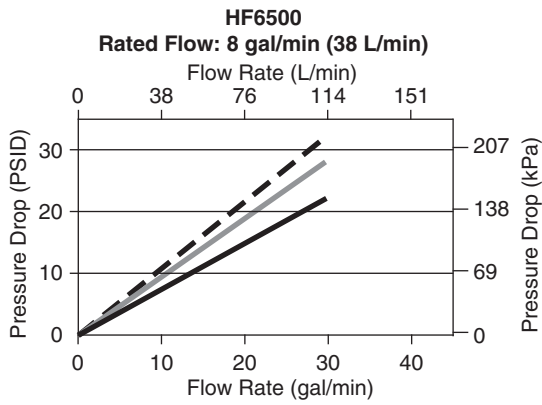

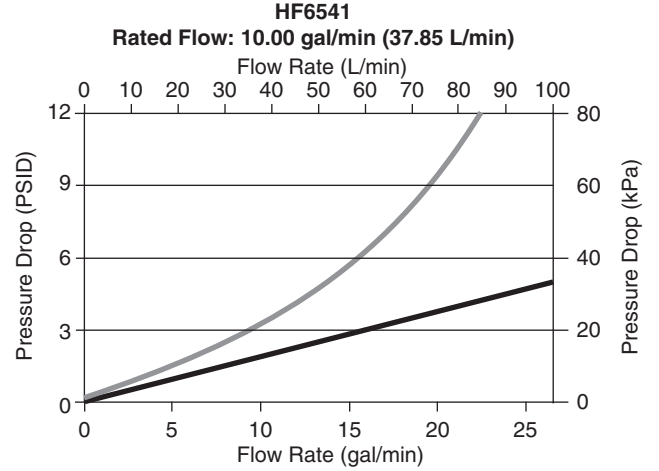
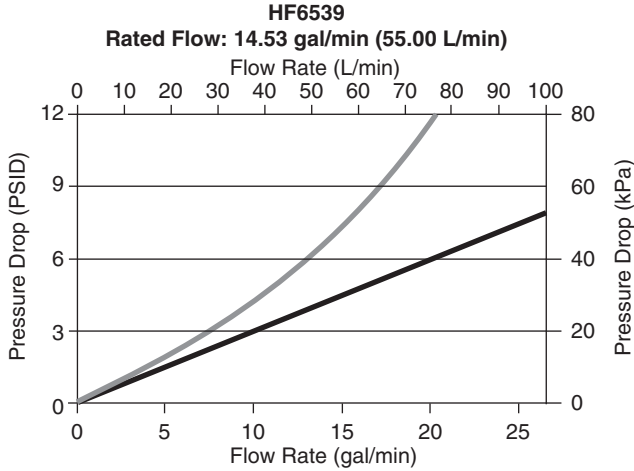
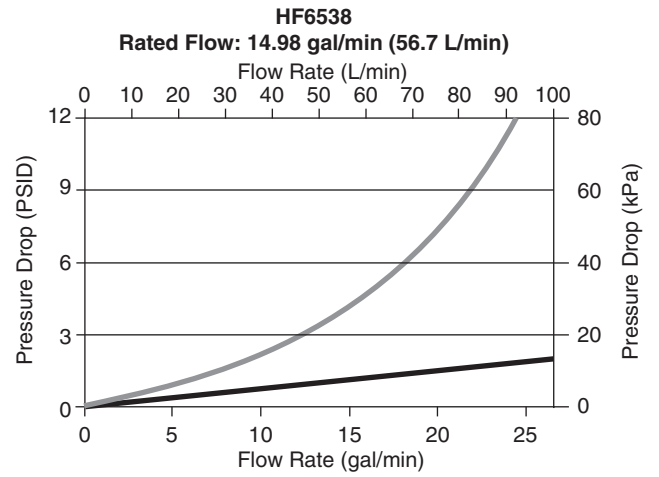
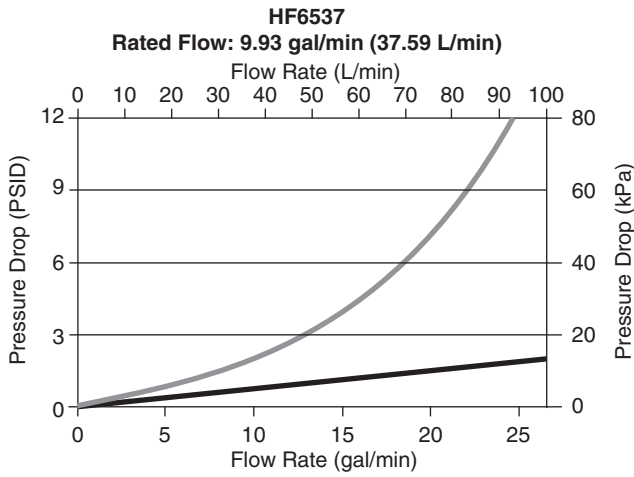
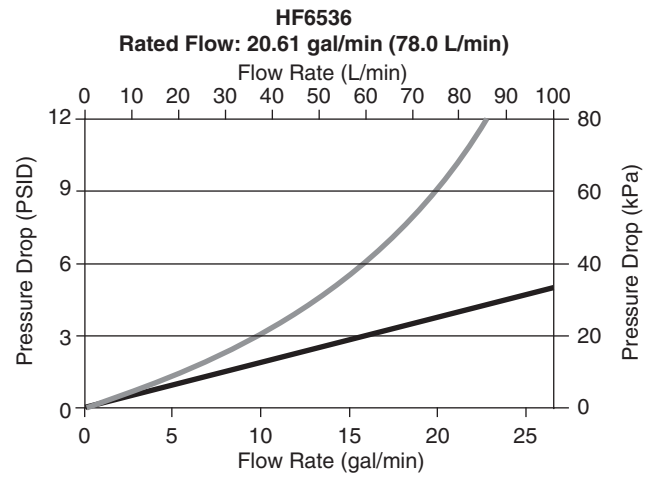
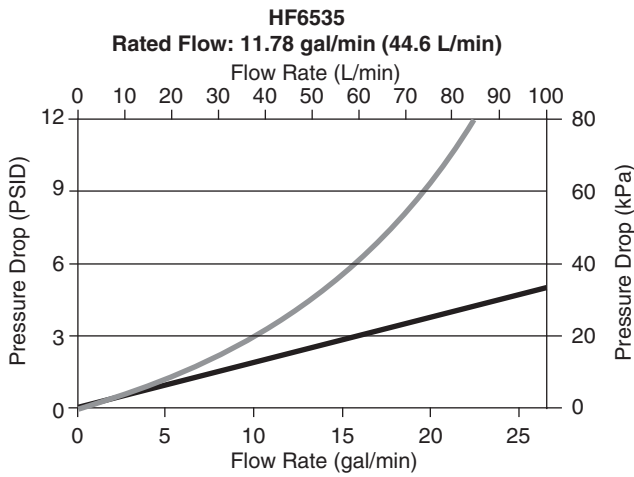

Legend

- Assembly with 3/4" (19.1 mm) BSP Ports
- Element

Flow/Pressure: 32 mm²/s
Rated Flow: @ 5 PSID (34 kPa) Across Filter



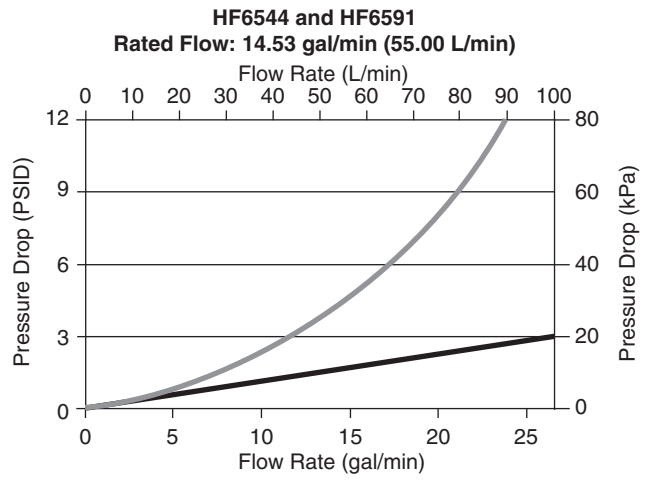
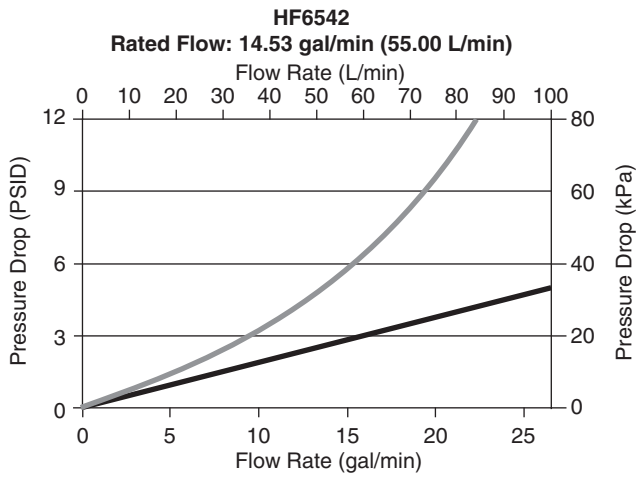

Legend

- Assembly with 3/4" (19.1 mm) BSP Ports
- Element

Flow/Pressure: 32 mm²/s
 Rated Flow: @ 5 PSID (34 kPa) Across Filter

HF6600 Series

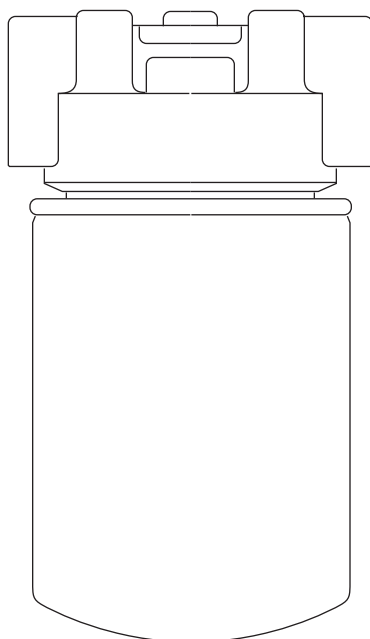

Specification	HF6600 Series
Rated Flow	Up to 35 gal/min (132 L/min)
Maximum Static Pressure	500 lb/in ² (3448 kPa)
Recommended Working Pressure (Non-shock operating conditions)	300 lb/in ² (2068 kPa)
Seals	Buna N
Filter Service Clearance	Min. 1.30" (33.02 mm)

Note: lb/in² is the standard SI notation for psi.
Specifications subject to change without notice.

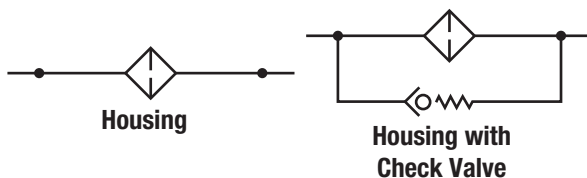

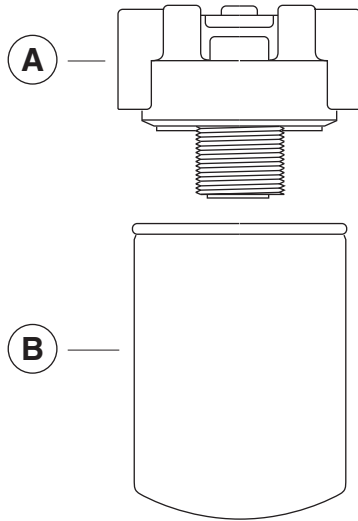

Part	Description	Part Number
A	Filter Head	See Ordering Information
B	Filter Element	See Ordering Information

Filter Head Part Number	Fluid In & Out Port Size	By-Pass Setting PSID (kPa)	Indicator Type
HH6931	1-1/16" 12 SAE	None	Electric*
HH6932		None	None
HH6936		25 (172.4)	None
HH6942	3/4" 14 NPTF	25 (172.4)	None

*Electric indicator is set at 15 PSID (103.4 kPa).

Part Number	b _{x(c)} > 200	b _{x(c)} > 75	b _{x(c)} > 2	Media	Element Length in (mm)	Fluid Compatibility
HF6603*	6	5	N/A	Synthetic	5.88 (149.35)	Petroleum and Water Base
HF6604*	6	5	N/A	Synthetic	8.00 (203.20)	Petroleum and Water Base
HF6606*	8	7	N/A	Synthetic	5.88 (149.35)	Petroleum and Water Base
HF6607*	8	7	N/A	Synthetic	8.00 (203.20)	Petroleum and Water Base
HF6612*	13	11	6	Synthetic	5.88 (149.35)	Petroleum and Water Base
HF6613*	13	11	6	Synthetic	8.00 (203.20)	Petroleum and Water Base
HF6625*	25	21	9	Synthetic	5.88 (149.35)	Petroleum and Water Base
HF6626*	25	21	9	Synthetic	8.00 (203.20)	Petroleum and Water Base
HF6630	6	13	4	Synthetic	5.88 (149.35)	Petroleum and Water Base
HF6631	13	11	6	Synthetic	8.00 (203.20)	Petroleum and Water Base
HF6632	27	21	10	Synthetic	5.88 (149.35)	Petroleum and Water Base
HF6633	24	21	9	Synthetic	8.00 (203.20)	Petroleum and Water Base
HF6600	N/A	11	4	Cellulose/Synthetic	5.88 (149.35)	Petroleum Base
HF6601	N/A	12	4	Cellulose/Synthetic	8.00 (203.20)	Petroleum Base
HF6610	N/A	47	14	Cellulose	5.88 (149.35)	Petroleum Base
HF6611	N/A	47	14	Cellulose	8.00 (203.20)	Petroleum Base
HF6620	N/A	29	13	Cellulose/Synthetic	5.88 (149.35)	Petroleum Base
HF6621	N/A	29	13	Cellulose/Synthetic	8.00 (203.20)	Petroleum Base

*Has epoxy potting material.

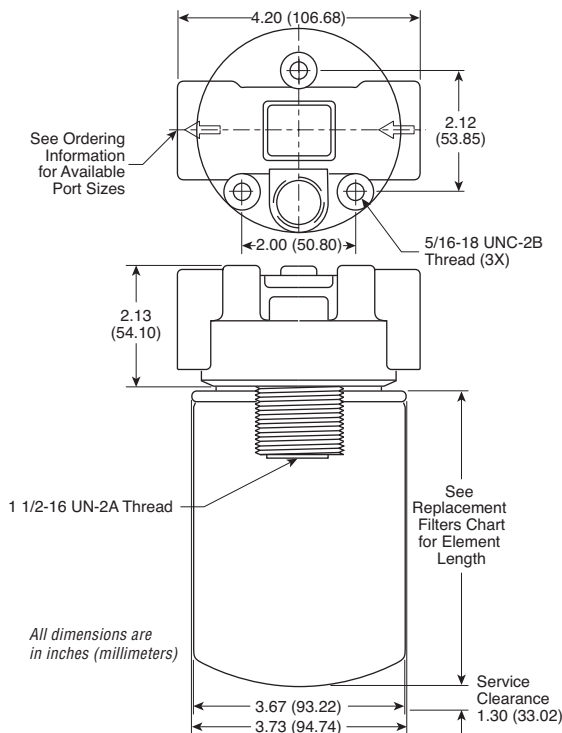

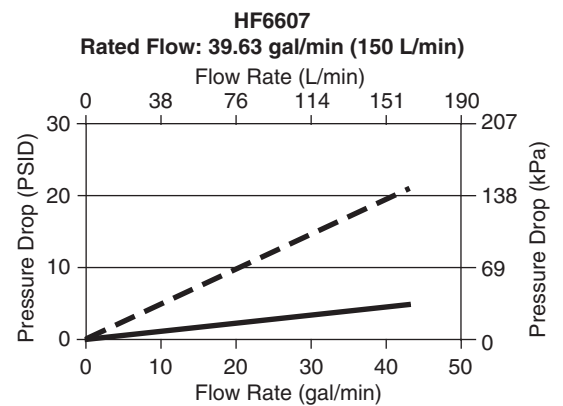
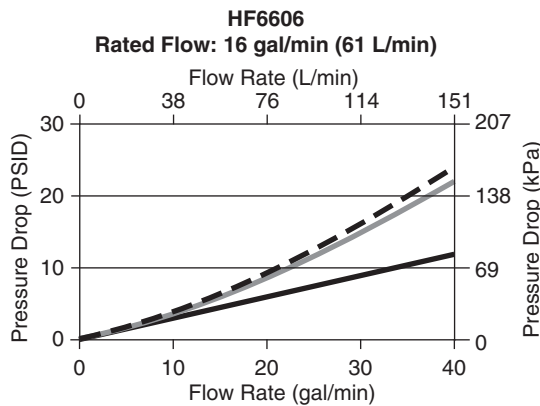
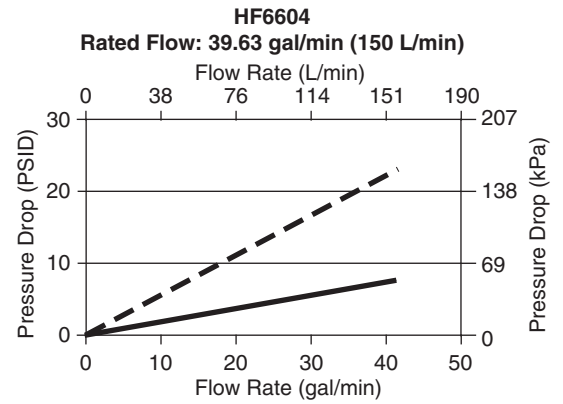
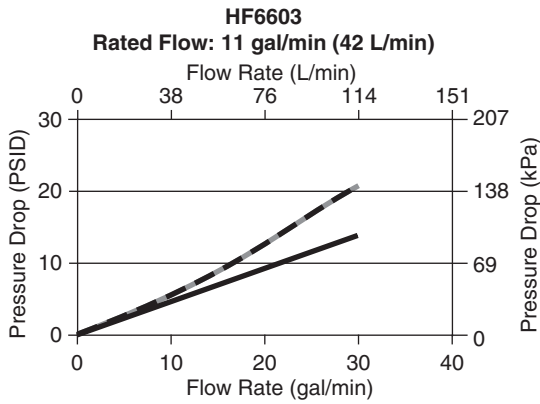
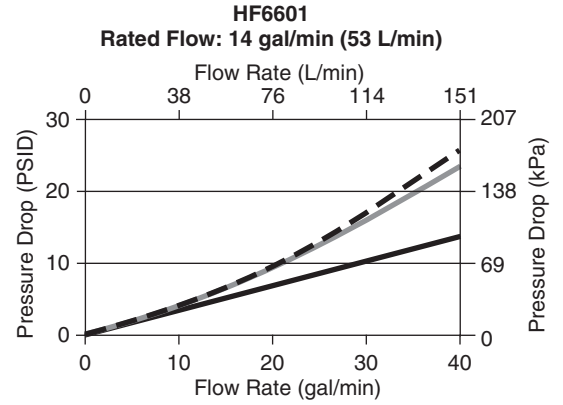
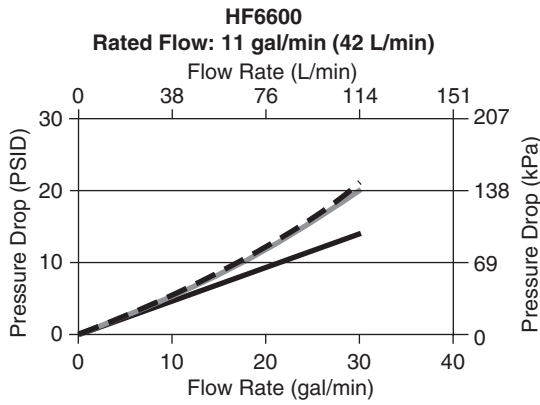

Legend

- Assembly with 1-1/16" (26.99 mm) and 3/4" (19.05 mm) Ports
- Assembly with 1-5/16" (33.34 mm) Ports
- Element

Flow/Pressure: 32 mm²/s
Rated Flow: @ 5 PSID (34 kPa) Across Filter

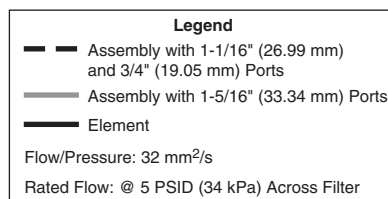
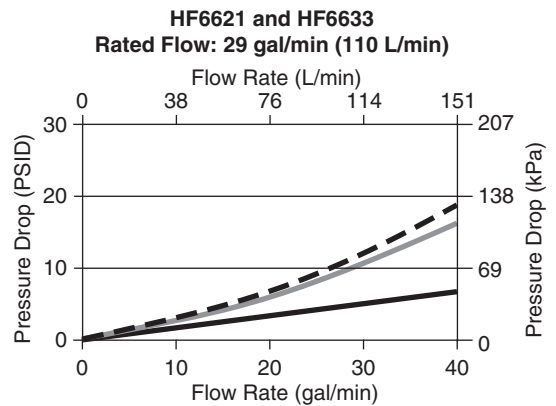
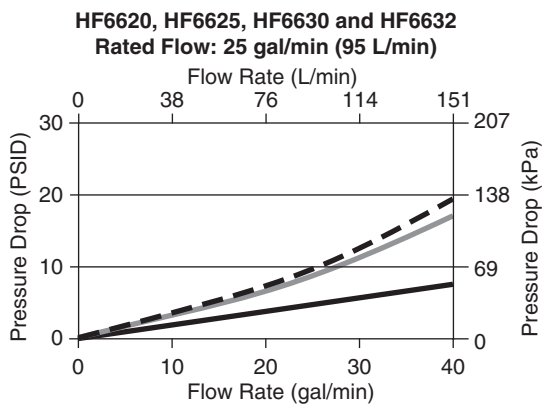
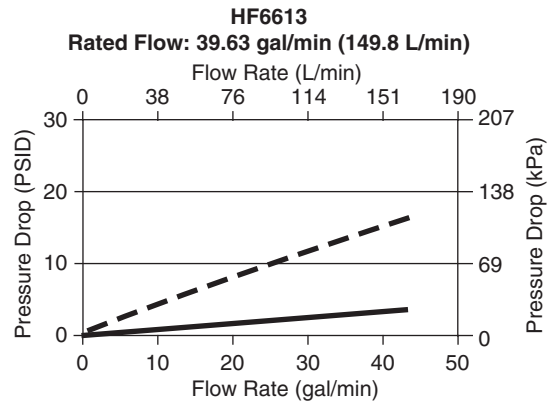
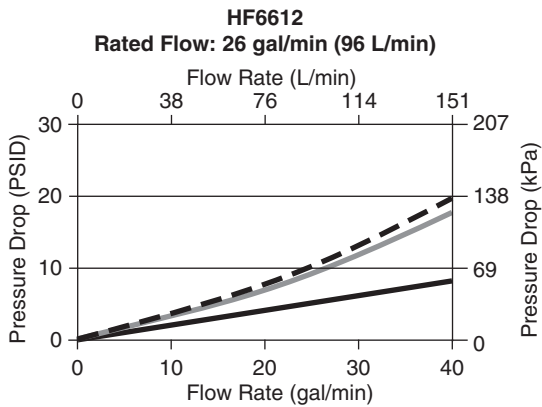
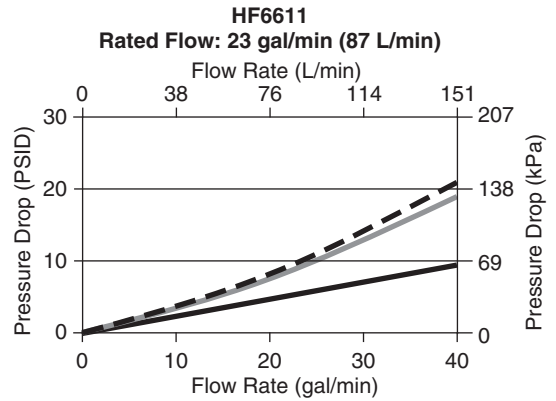
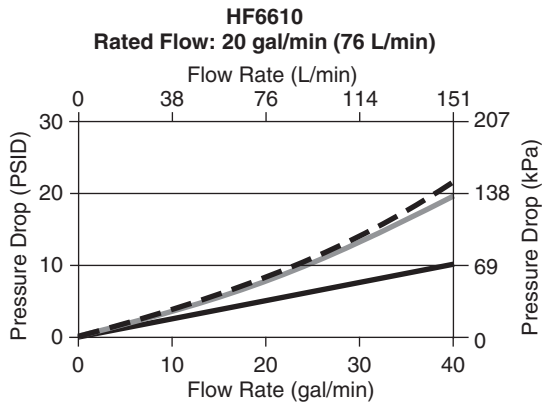

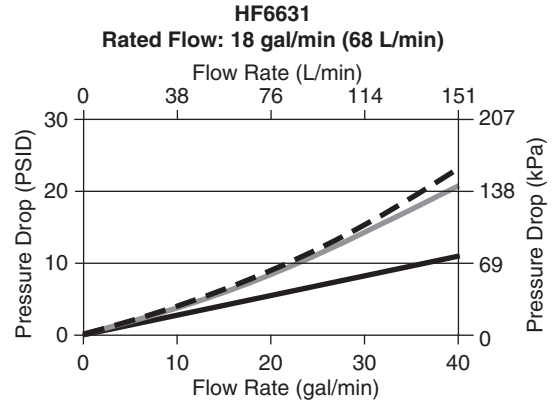
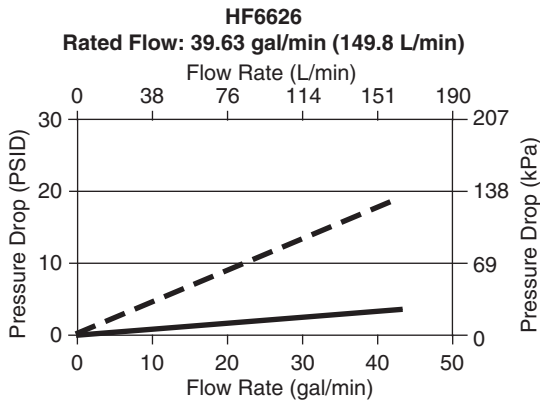

Legend

- Assembly with 1-1/16" (26.99 mm) and 3/4" (19.05 mm) Ports
- Assembly with 1-5/16" (33.34 mm) Ports
- Element

Flow/Pressure: 32 mm²/s
 Rated Flow: @ 5 PSID (34 kPa) Across Filter

HF6700 Series

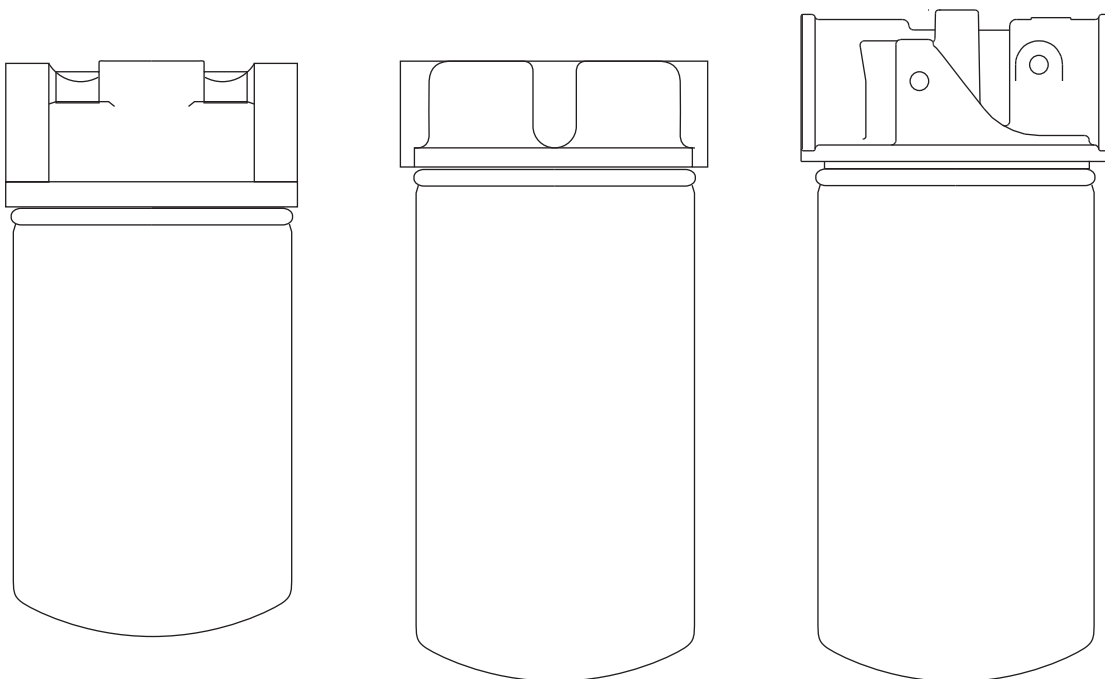

Specification	HF6700 Series – Styles A and B	HF6700 Series – Style C
Rated Flow	Up to 55 gal/min (208 L/min)	See Ordering Information
Maximum Static Pressure	300 lb/in ² (2068 kPa)	260 lb/in ² (1800 kPa)
Recommended Working Pressure (Non-shock operating conditions)	200 lb/in ² (1379 kPa)	175 lb/in ² (1200 kPa)
Seals	Buna N	Buna N
Filter Service Clearance	Min. 1.50" (38.10 mm)	Min. 1.50" (38.10 mm)

Note: lb/in² is the standard SI notation for psi.
Specifications subject to change without notice.

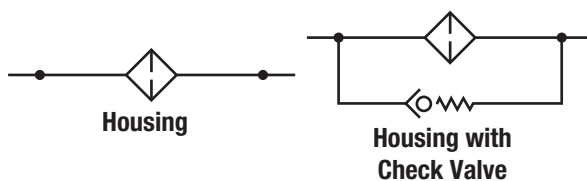

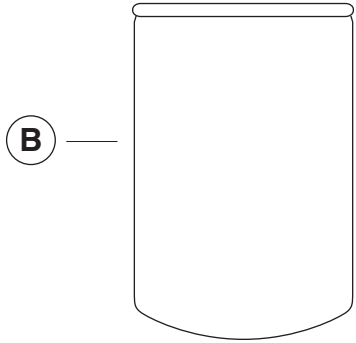
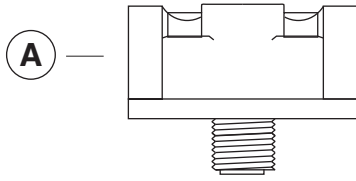

Part	Description	Part Number
A	Filter Head	See Ordering Information
B	Filter Element	See Ordering Information

Filter Head Part Number	Fluid In & Out Port Size	By-Pass Setting PSID (kPa)	Indicator Type*
HH6962	1-1/4" NPTF	None	None
HH6963		4 (27.6)	None
HH6965		25 (172.4)	None
HH6967	1-1/2" NPTF	None	None
HH6970		25 (172.4)	None
HH6972	1-5/8" NPTF	25 (172.4)	None
HH6973		None	None

* Can be drilled and tapped for pressure and/or vacuum gauges.

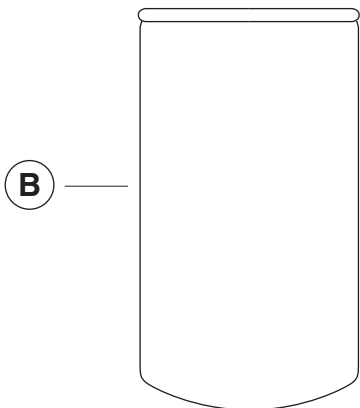
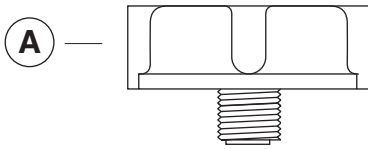

Part	Description	Part Number
A	Filter Head	See Ordering Information
B	Filter Element	See Ordering Information

Filter Head Part Number	Fluid In & Out Port Size	By-Pass Setting PSID (kPa)	Indicator Type
HH6951	1-5/16" 12 SAE	None	None
HH6955		25 (172.4)	None
HH6957	1" NPTF	None	None
HH6961		25 (172.4)	None

* Electric indicator is set at 15 PSID (103.4 kPa).

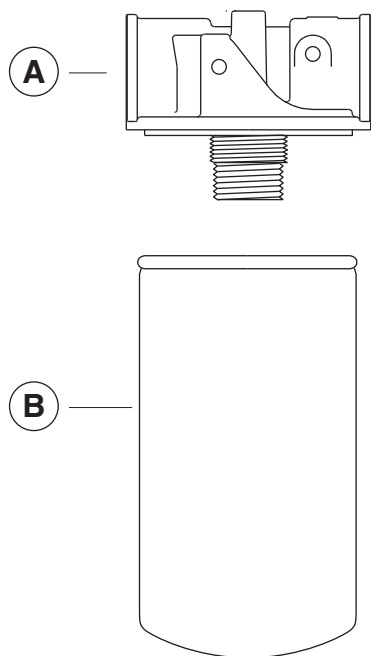

Part	Description	Part Number
A	Filter Head	See Ordering Information
B	Filter Element	See Ordering Information
	Clogging Indicator (not shown)	See Ordering Information

Filter Head Part Number	Fluid In & Out Port Size	By-Pass Setting PSID (kPa)	Rated Flow gal/min (L/min)	Indicator Type*
ST1028HH	1-1/4" BSP	4 (25)	13 (50)	Vacuum Gauge
ST1297HH		51 (350)	58 (220)	Pressure Gauge

* Units are pre-drilled with 1/8" BSP tappings for the installation of pressure and/or vacuum gauges. See ordering information below.

Part Number	Description
ST1398MR	Pressure gauge for return line application

Part Number ¹	b _{x(c)} > 200	b _{x(c)} > 75	b _{x(c)} > 2	Media	Element Length in (mm)	Fluid Compatibility
Styles A and B						
HF6703 ²	6	5	N/A	Synthetic	6.63 (168.40)	Petroleum and Water Base
HF6704 ²	6	5	N/A	Synthetic	10.63 (270.00)	Petroleum and Water Base
HF6706 ²	8	7	N/A	Synthetic	6.63 (168.40)	Petroleum and Water Base
HF6707 ²	8	7	4	Synthetic	10.63 (270.00)	Petroleum and Water Base
HF6712 ²	13	11	6	Synthetic	6.63 (168.40)	Petroleum and Water Base
HF6713 ²	13	11	6	Synthetic	10.63 (270.00)	Petroleum and Water Base
HF6725 ²	25	21	9	Synthetic	6.63 (168.40)	Petroleum and Water Base
HF6726 ²	25	21	9	Synthetic	10.63 (270.00)	Petroleum and Water Base
HF6730	N/A	11	6	Synthetic	6.63 (168.40)	Petroleum and Water Base
HF6731	N/A	11	6	Synthetic	10.63 (270.00)	Petroleum and Water Base
HF6732	N/A	25	10	Synthetic	6.63 (168.40)	Petroleum and Water Base
HF6733	N/A	29	10	Synthetic	10.63 (270.00)	Petroleum and Water Base
HF6700	N/A	11	4	Cellulose/Synthetic	6.63 (168.40)	Petroleum Base
HF6701	N/A	11	4	Cellulose/Synthetic	10.63 (270.00)	Petroleum Base
HF6710	N/A	47	14	Cellulose	6.63 (168.40)	Petroleum Base
HF6711	N/A	47	14	Cellulose	10.63 (270.00)	Petroleum Base
HF6720	N/A	29	13	Cellulose/Synthetic	6.63 (168.40)	Petroleum Base
HF6721	N/A	29	13	Cellulose/Synthetic	10.63 (270.00)	Petroleum Base
HF6722	– ³	140	– ³	Wire Mesh	6.63 (168.40)	Petroleum and Water Base
HF6723	– ³	140	– ³	Wire Mesh	10.63 (270.00)	Petroleum and Water Base
Style C						
HF6177	–	26	10	Cellulose	7.09 (180.00)	Petroleum Base
HF35082	–	26	10	Cellulose	8.94 (227.00)	Petroleum Base
HF7835	–	47	14	Cellulose	7.09 (180.00)	Petroleum Base
HF6359	–	47	14	Cellulose	8.94 (227.00)	Petroleum Base
HF7980	14	10	5	Glass Fiber	7.09 (180.00)	Petroleum and Water Base
ST1917	14	10	5	Glass Fiber	8.94 (227.00)	Petroleum and Water Base
ST1814	–	90	–	Wire Mesh	7.09 (180.00)	Petroleum and Water Base

¹ Other seals can be ordered separately:
 Part number 3312097 S – RECTANGULAR Cross Section Seal
 Part number 3830114 S – SQUARE CUT Viton Seal

² Has epoxy potting material.

³ These elements are made with 100 mesh screen (140 micron, absolute) and are not multi-pass tested.

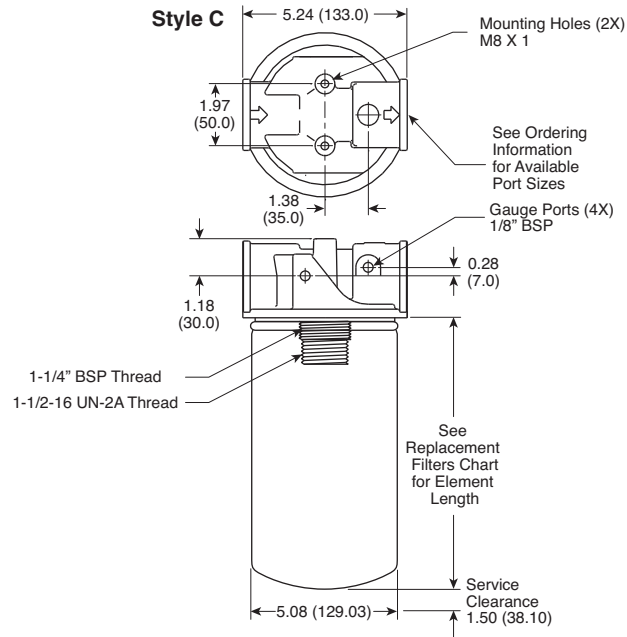
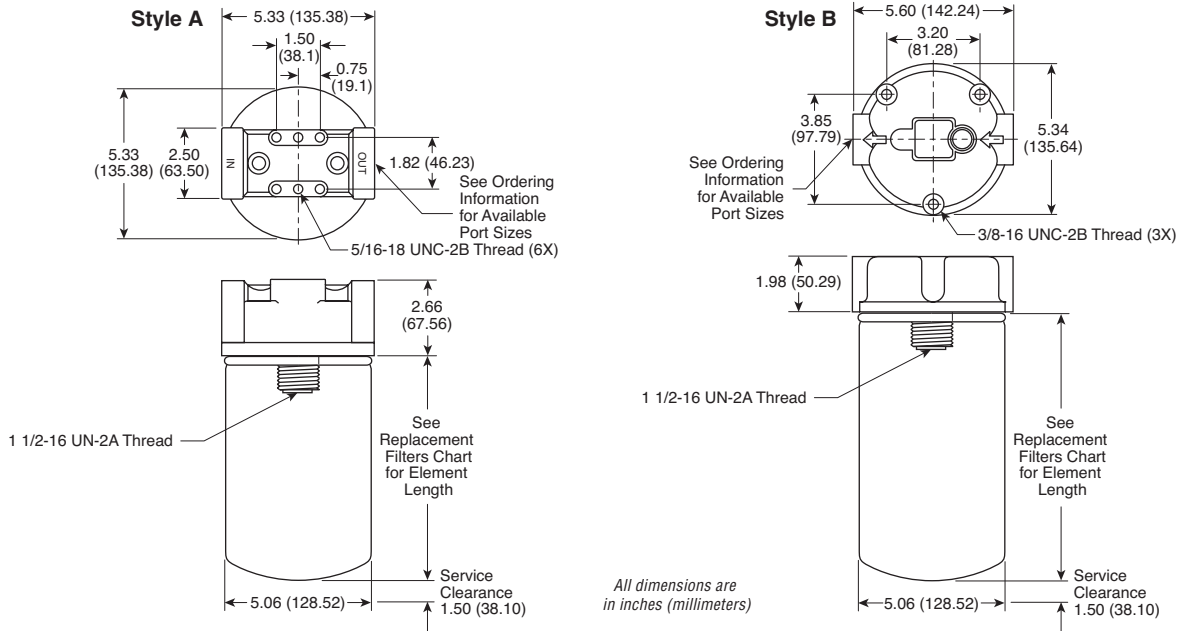

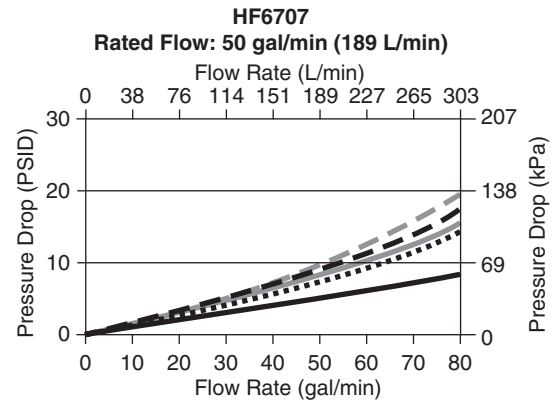
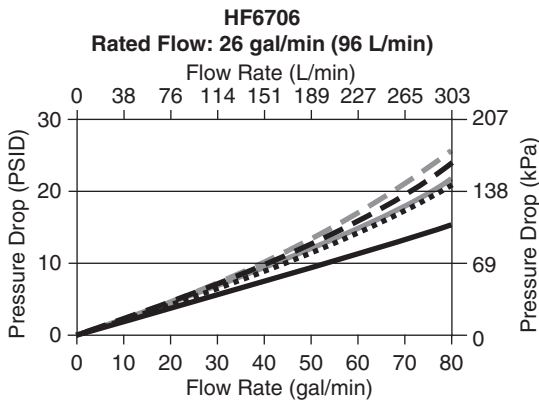
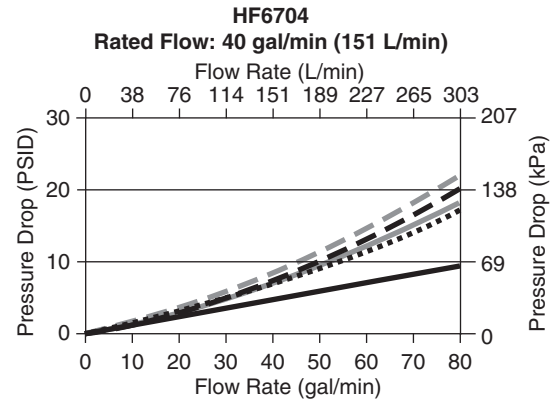
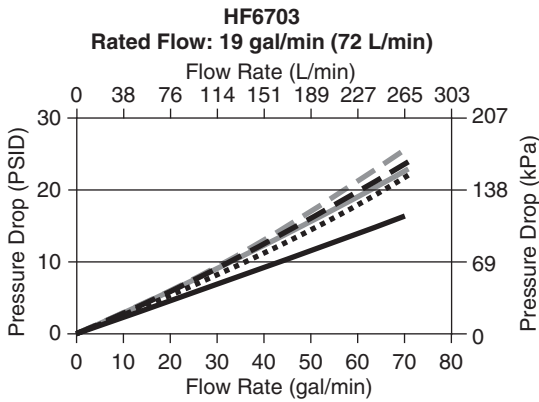
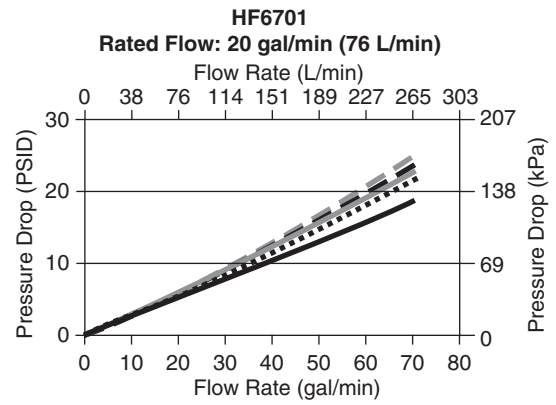
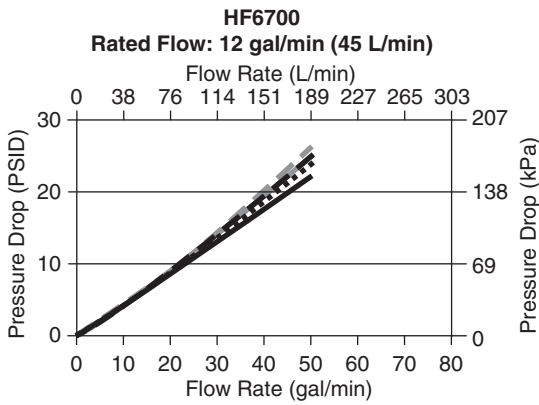

Legend	
	Assembly with 1-1/4" (31.75 mm) Ports
	Assembly with 1-5/16" (33.34 mm) Ports
	Assembly with 1-5/8" (47.28 mm) Ports
	Assembly with 1-1/2" (38.1 mm) Ports
	Element
Flow/Pressure: 32 mm ² /s	
Rated Flow: @ 5 PSID (34 kPa) Across Filter	

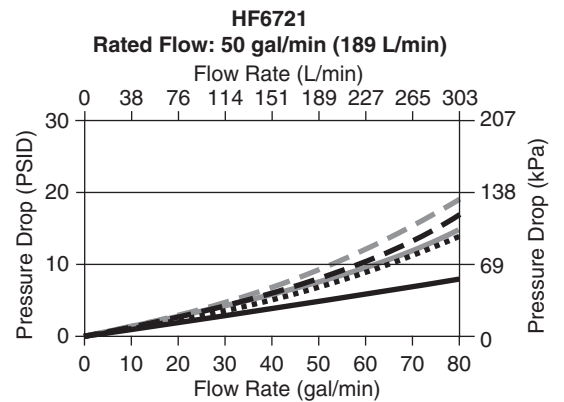
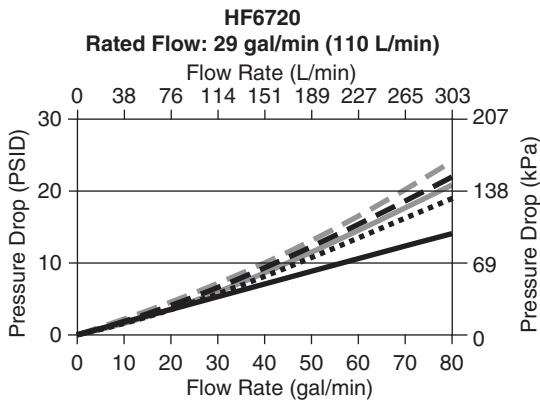
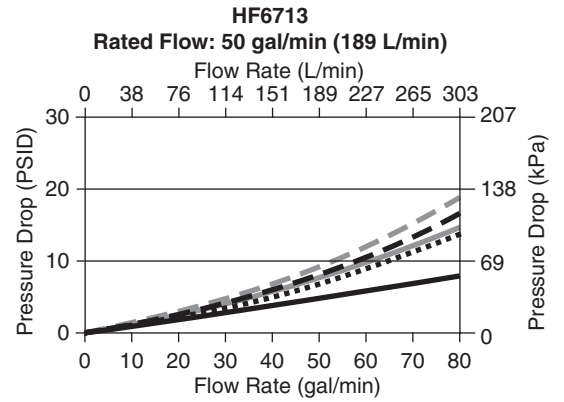
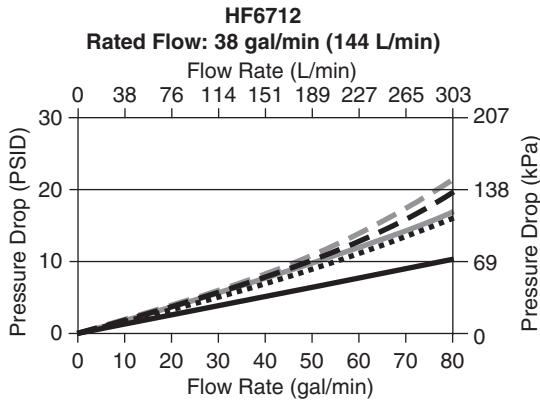
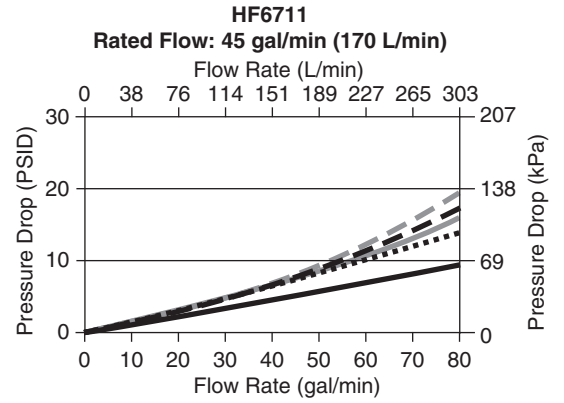
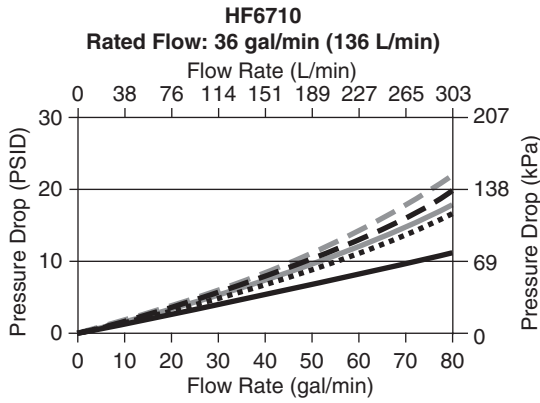

Legend	
	Assembly with 1-1/4" (31.75 mm) Ports
	Assembly with 1-5/16" (33.34 mm) Ports
	Assembly with 1-5/8" (47.28 mm) Ports
	Assembly with 1-1/2" (38.1 mm) Ports
	Element
Flow/Pressure: 32 mm ² /s	
Rated Flow: @ 5 PSID (34 kPa) Across Filter	



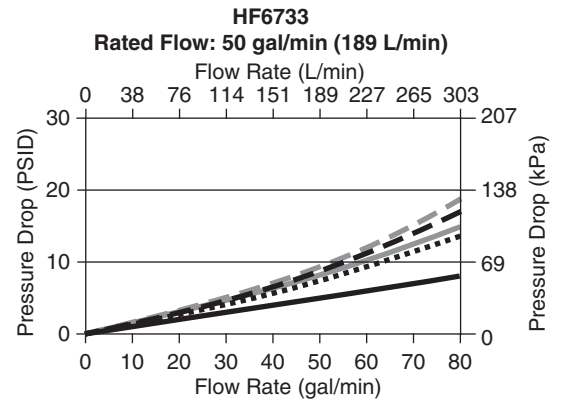
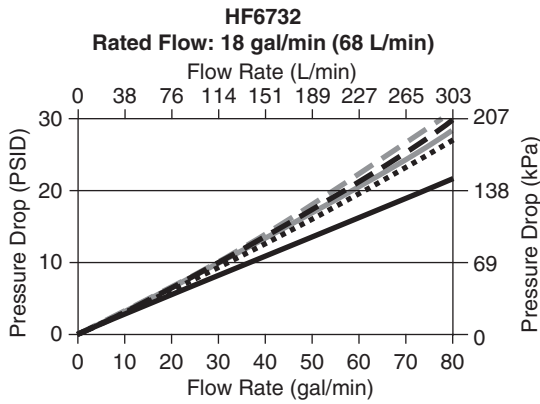
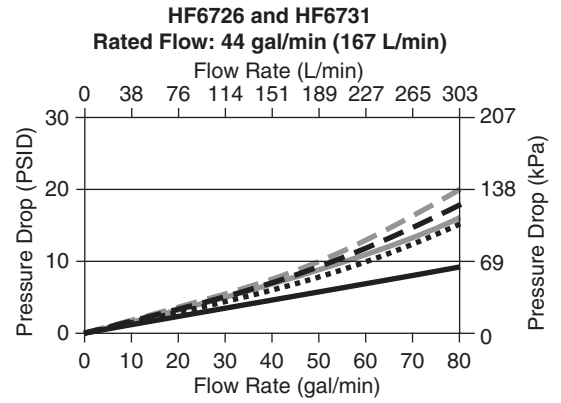
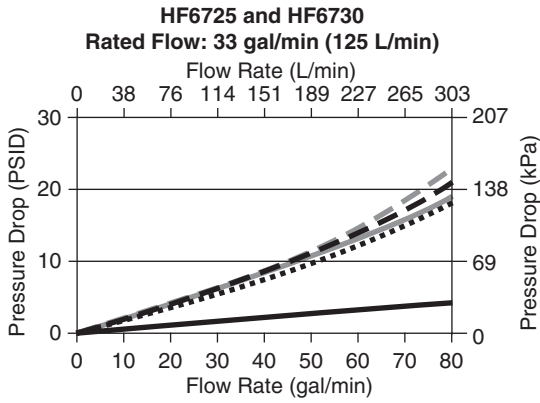

Legend	
— —	Assembly with 1-1/4" (31.75 mm) Ports
- . - .	Assembly with 1-5/16" (33.34 mm) Ports
—	Assembly with 1-5/8" (47.28 mm) Ports
.....	Assembly with 1-1/2" (38.1 mm) Ports
—	Element
Flow/Pressure: 32 mm ² /s	
Rated Flow: @ 5 PSID (34 kPa) Across Filter	

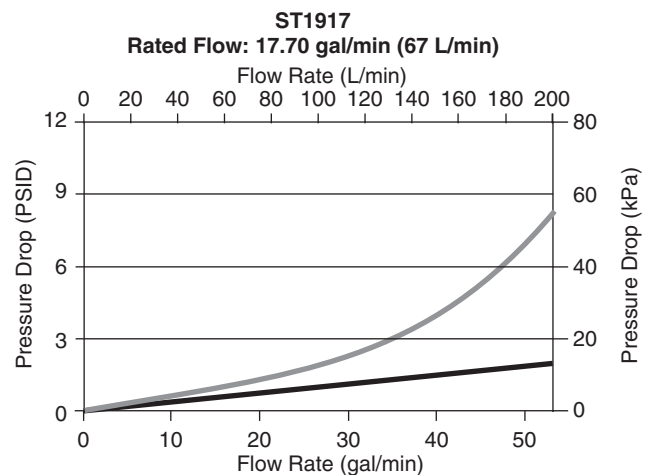
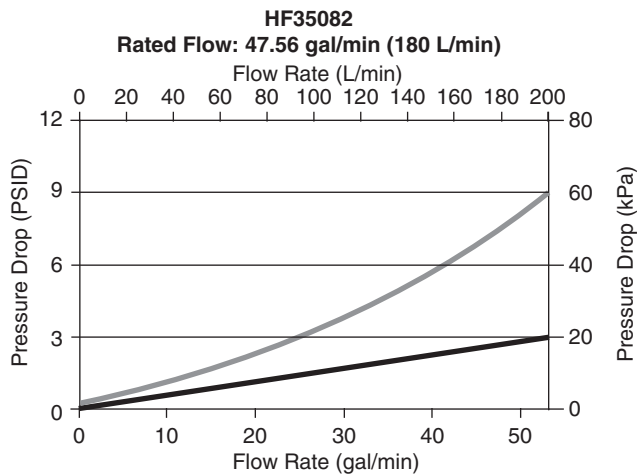
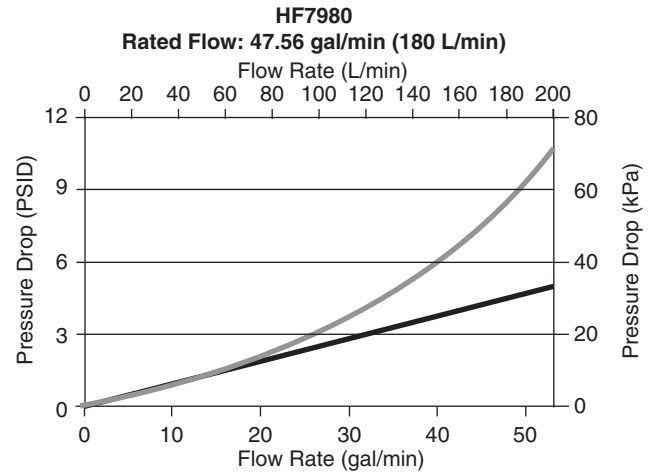
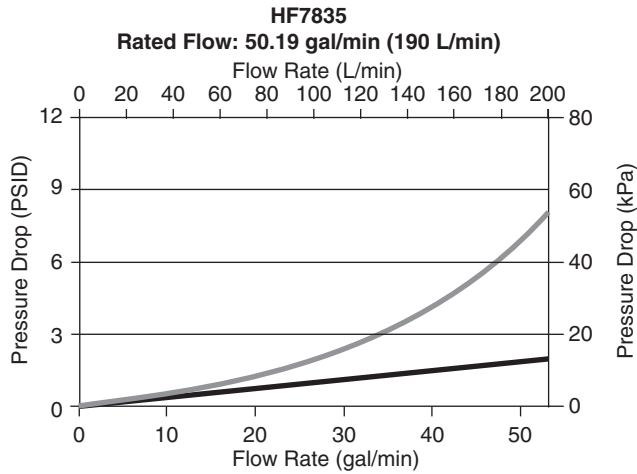
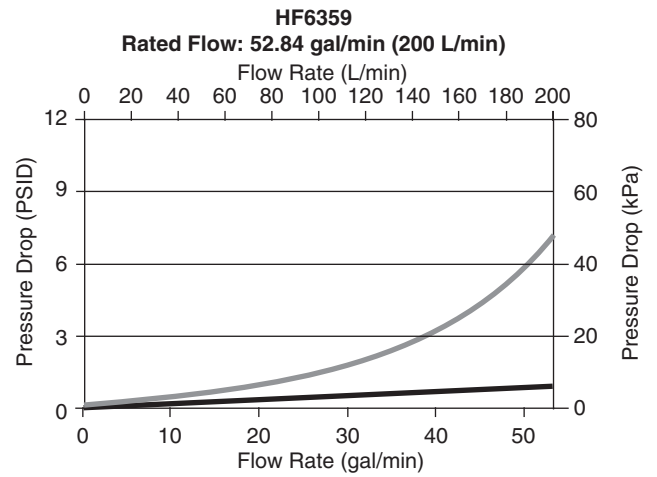
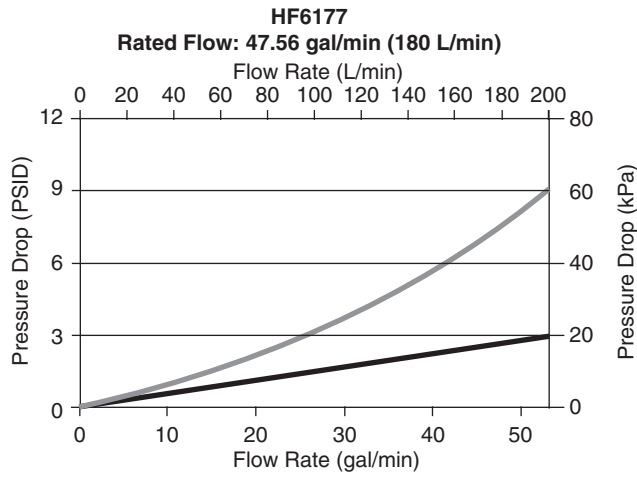

Legend

- Assembly with 1-1/4" (32 mm) BSP Ports
- Element

Flow/Pressure: 32 mm²/s
 Rated Flow: @ 5 PSID (34 kPa) Across Filter



HF6800 Series

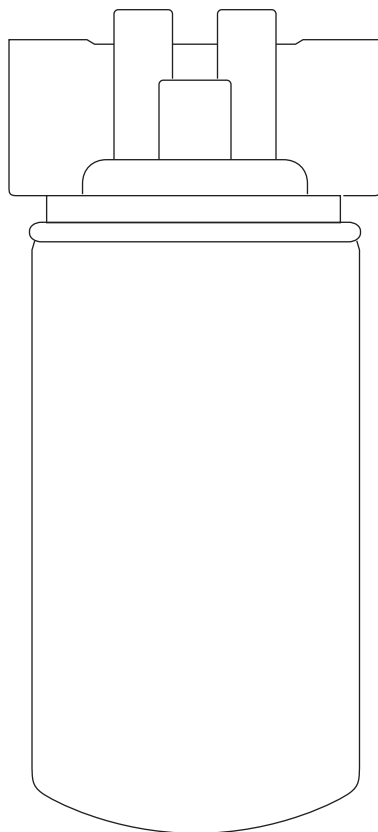

Specification	HF6800 Series
Rated Flow	Up to 40 gal/min (151 L/min)
Maximum Static Pressure	700 lb/in ² (4826 kPa)
Recommended Working Pressure (Non-shock operating conditions)	400 lb/in ² (2758 kPa)
Seals	Buna N
Filter Service Clearance	Min. 1.50" (38.10 mm)

Note: lb/in² is the standard SI notation for psi.
Specifications subject to change without notice.



Housing with
Check Valve

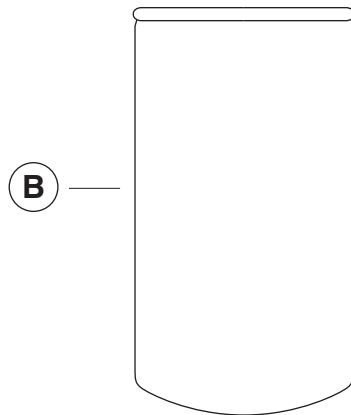
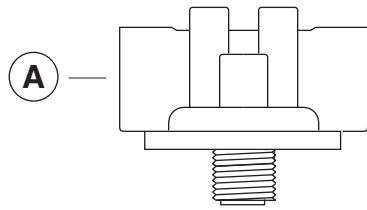

Part	Description	Part Number
A	Filter Head	See Ordering Information
B	Filter Element	See Ordering Information

Filter Head Part Number	Fluid In & Out Port Size	By-Pass Setting PSID (kPa)	Indicator Type*
HH6962*	1-1/4" NPTF	None	None
HH6963*		4 (27.6)	None
HH6965*		25 (172.4)	None
HH6967*	1-1/2" NPTF	None	None
HH6970*		25 (172.4)	None
HH6972*	1-5/8" NPTF	25 (172.4)	None
HH6973*		None	None



* These Heads require the Male port ends will need to be converted to NPTP from SAE..

Part Number	b _{x(c)} > 200	b _{x(c)} > 75	b _{x(c)} > 2	Media	Element Length in (mm)	Fluid Compatibility
HF6802	21	18	7	Synthetic	8.22 (208.79)	Petroleum and Water Base
HF6807	10	7	4	Synthetic	11.71 (297.43)	Petroleum and Water Base
HF6813	12	11	5	Synthetic	11.71 (297.43)	Petroleum and Water Base
HF6824	21	18	7	Synthetic	11.72 (297.69)	Petroleum and Water Base

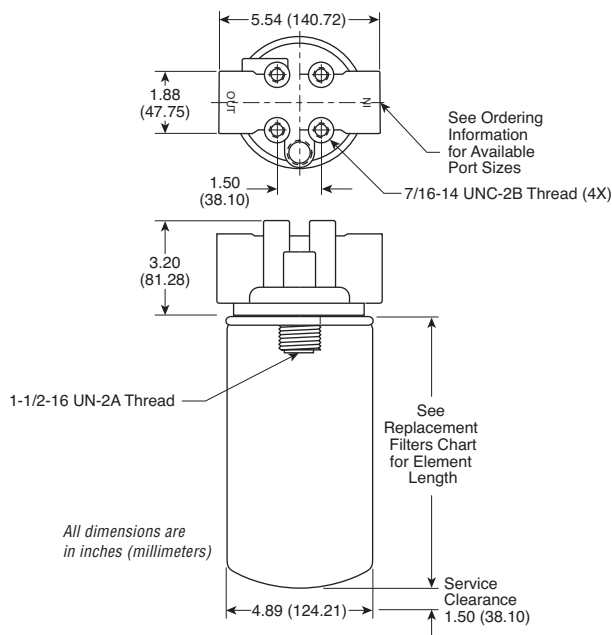
* Has epoxy potting material.

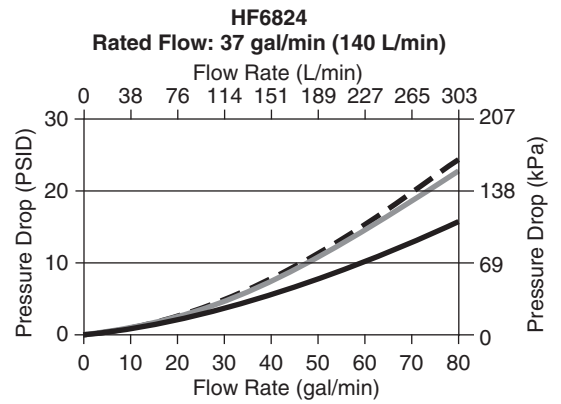
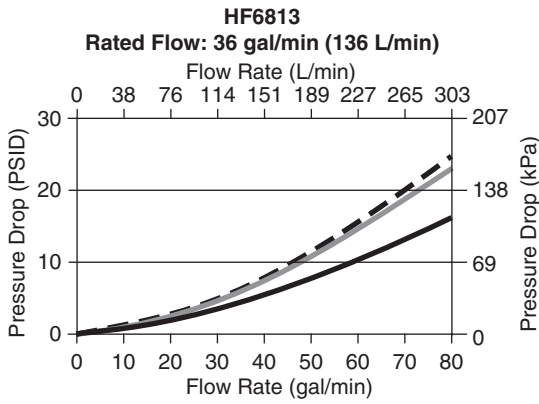
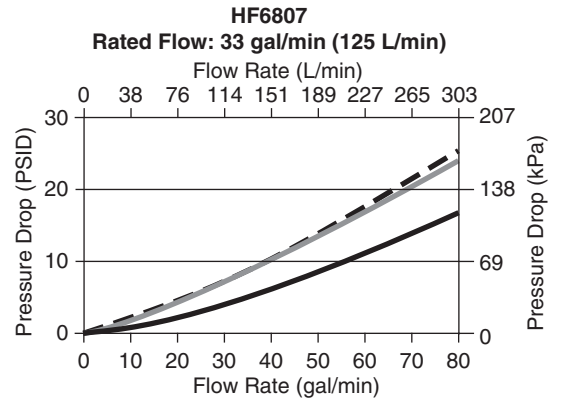
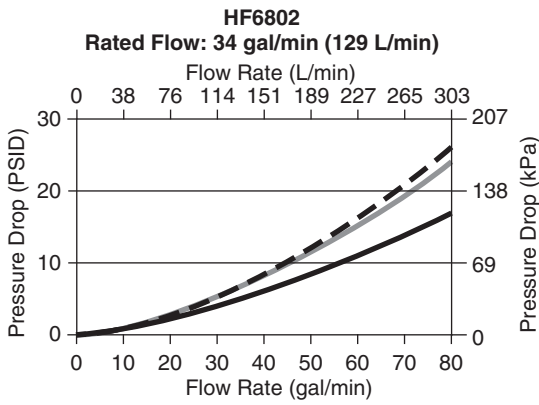



Legend	
	Assembly with 1-5/8" (41.28 mm) Ports
	Assembly with 1-5/16" (33.34 mm) Ports
	Element
Flow/Pressure: 32 mm ² /s	
Rated Flow: @ 5 PSID (34 kPa) Across Filter	

Dual Spin-On Assembly

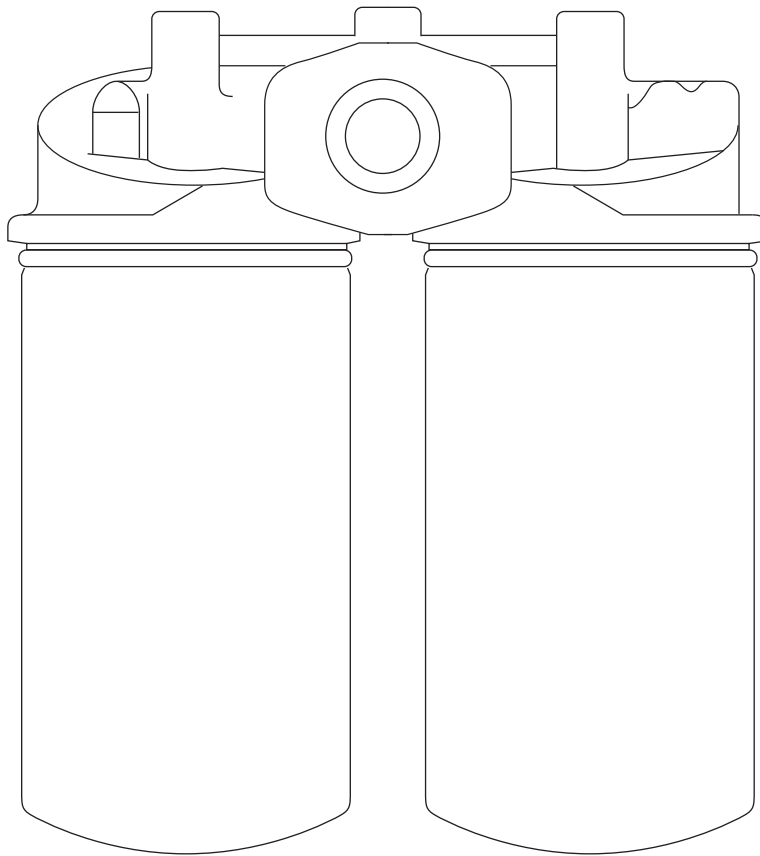

Specification	Dual Spin-On Assembly
Rated Flow	See Ordering Information
Maximum Static Pressure	260 lb/in ² (1800 kPa)
Recommended Working Pressure (Non-shock operating conditions)	175 lb/in ² (1200 kPa)
Seals	Buna N
Filter Service Clearance	Min. 1.30" (33.02 mm)

Note: lb/in² is the standard SI notation for psi.
Specifications subject to change without notice.

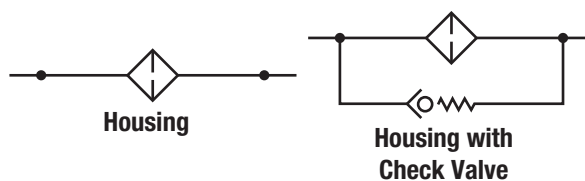

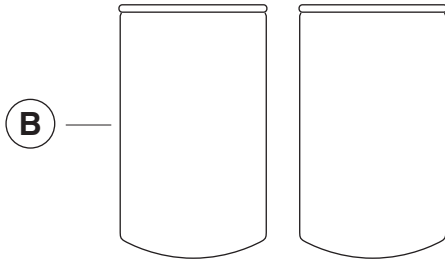
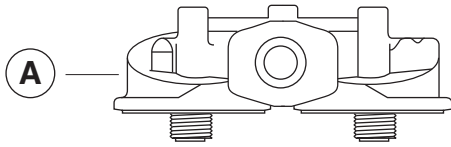

Part	Description	Part Number
A	Filter Head	See Ordering Information
B	Filter Elements	See Ordering Information
	Clogging Indicator (not shown)	See Ordering Information

Filter Head Part Number	Fluid In & Out Port Size	By-Pass Setting PSID (kPa)	Rated Flow gal/min (L/min)	Indicator Type*
ST1927HH	1-1/2" BSP	Closed By-Pass	34.3 (130)	Vacuum Gauge
ST1416HH		1200 (175)	118.9 (450)	Pressure Gauge

* Units are pre-drilled with 1/8" BSP tappings for the installation of pressure and/or vacuum gauges. See ordering information below.

Part Number	Description
ST1429MA	Vacuum gauge for suction line application
ST1398MR	Pressure gauge for return line application
ST1750IC	Differential Pressure pop-up Indicator

Part Number ¹	$b_{x(c)} > 200$	$b_{x(c)} > 75$	$b_{x(c)} > 2$	Media	Element Length	Fluid Compatibility
HF6177	–	26	10	Cellulose	7.09 (180.00)	Petroleum Base
HF35082	–	26	10	Cellulose	8.94 (227.00)	Petroleum Base
HF7835	–	47	14	Cellulose	7.09 (180.00)	Petroleum Base
HF6359	–	47	14	Cellulose	8.94 (227.00)	Petroleum Base
HF7980	14	10	5	Glass Fiber	7.09 (180.00)	Petroleum and Water Base
ST1917	14	10	5	Glass Fiber	8.94 (227.00)	Petroleum and Water Base
ST1814	–	90	–	Wire Mesh	7.09 (180.00)	Petroleum and Water Base

¹ Other seals can be ordered separately:

Part number 3312097 S – RECTANGULAR Cross Section Seal

Part number 3830114 S – SQUARE CUT Viton Seal

² Has epoxy potting material.

³ These elements are made with 100 mesh screen (140 micron, absolute) and are not multi-pass tested.

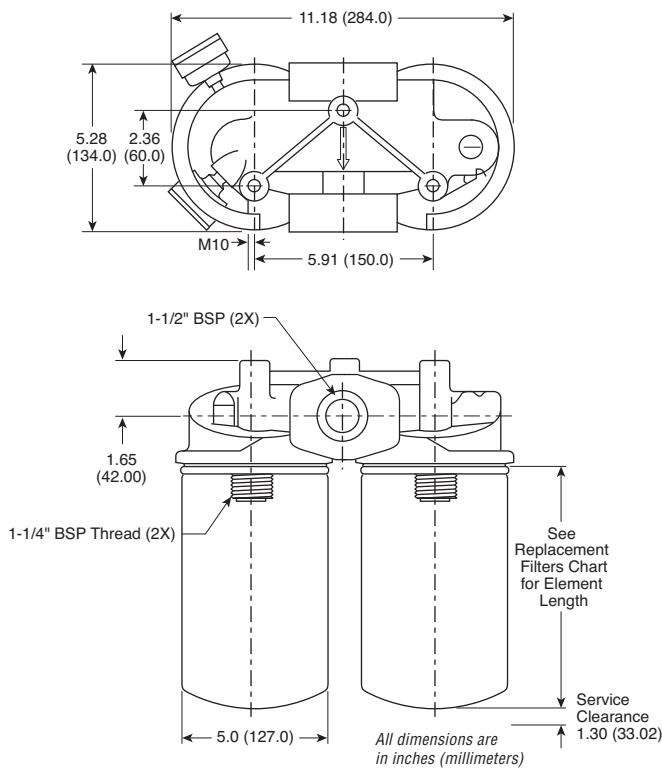

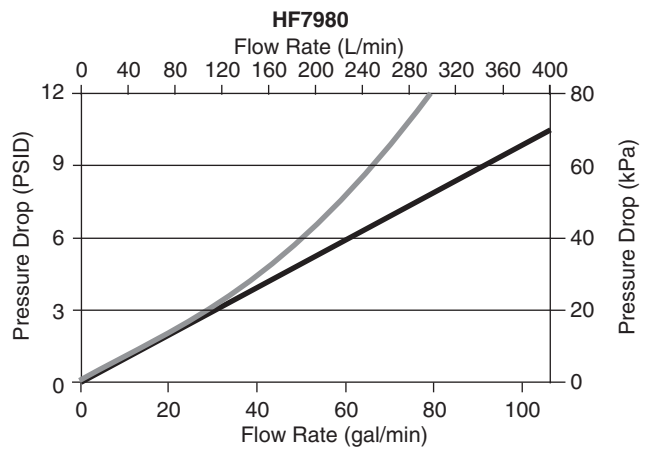
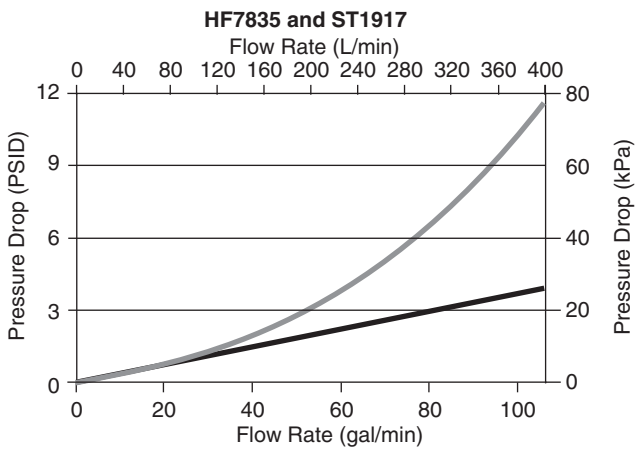
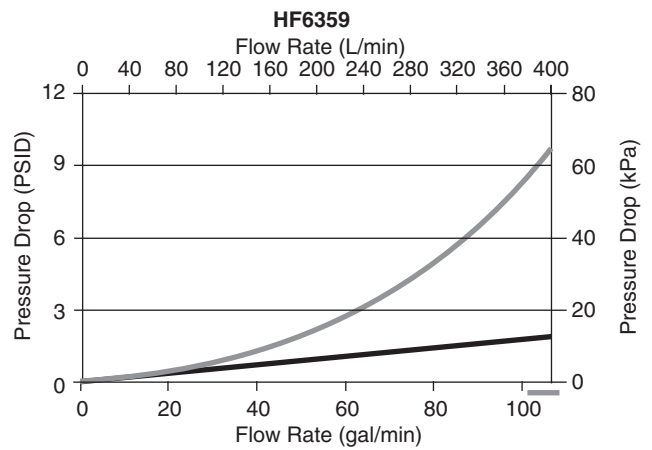
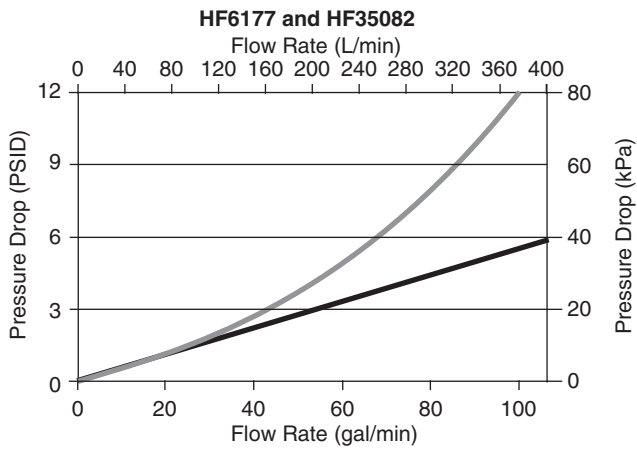

Legend

- Assembly with 1-1/2" (38 mm) BSP Ports
- Element

Flow/Pressure: 32 mm²/s
 Rated Flow: @ 5 PSID (34 kPa) Across Filter

Discontinued Parts

HF6600 Series

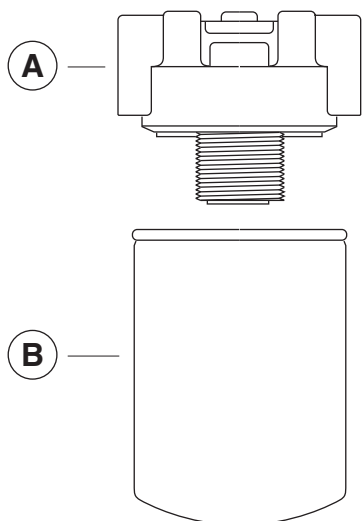

Part	Description	Part Number
A	Filter Head	See Ordering Information
B	Filter Element	See Ordering Information

Filter Head Part Number	Fluid In & Out Port Size	By-Pass Setting PSID (kPa)	Indicator Type
HH6926	1-5/16" 12 SAE	None	None
HH6930		25 (172.4)	None
HH6935	1-1/16" 12 SAE	25 (172.4)	Electric*
HH6938	3/4" 14 NPTF	None	None

* Electric indicator is set at 15 PSID (103.4 kPa).

HF6700 Series

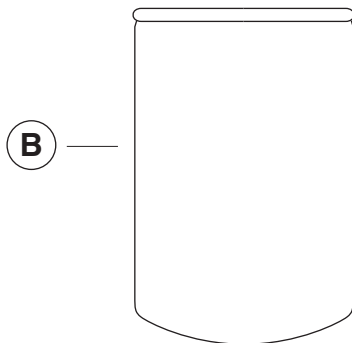
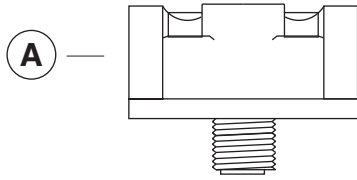

Part	Description	Part Number
A	Filter Head	See Ordering Information
B	Filter Element	See Ordering Information

Filter Head Part Number	Fluid In & Out Port Size	By-Pass Setting PSID (kPa)	Indicator Type*
HH6968	1-1/2" NPTF	4 (27.6)	None

* Can be drilled and tapped for pressure and/or vacuum gauges.

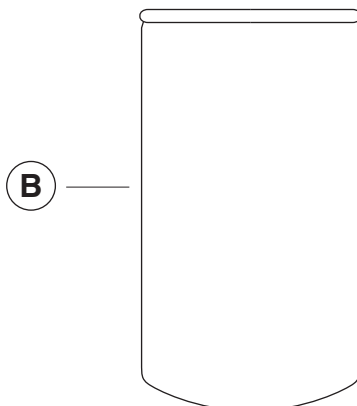
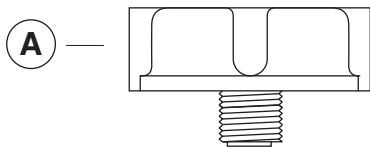

Part	Description	Part Number
A	Filter Head	See Ordering Information
B	Filter Element	See Ordering Information

Filter Head Part Number	Fluid In & Out Port Size	By-Pass Setting PSID (kPa)	Indicator Type
HH6954	1-5/16" 12 SAE	25 (172.4)	Electric*
HH6956	1" NPTF	None	Electric*
HH6959		4 (27.6)	None
HH6960		25 (172.4)	Electric*

* Electric indicator is set at 15 PSID (103.4 kPa).

HF6700 Series

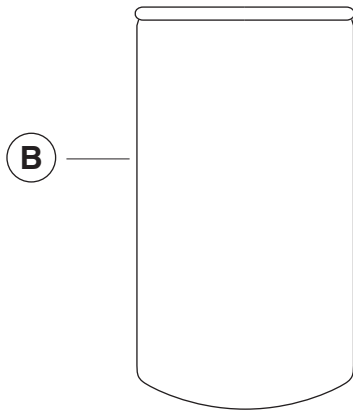
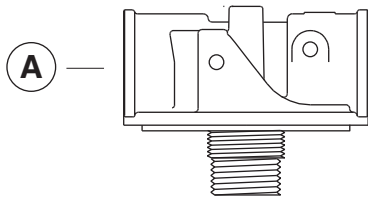

Part	Description	Part Number
A	Filter Head	See Ordering Information
B	Filter Element	See Ordering Information
	Clogging Indicator (not shown)	See Ordering Information

Filter Head Part Number	Fluid In & Out Port Size	By-Pass Setting PSID (kPa)	Rated Flow gal/min (L/min)	Indicator Type*
ST1029HH	1-1/4" BSP	25 (175)	58 (220)	Pressure Gauge

* Units are pre-drilled with 1/8" BSP tapings for the installation of pressure and/or vacuum gauges. See ordering information below.

Part Number	Description
ST1429MA	Vacuum gauge for suction line application

HF6800 Series

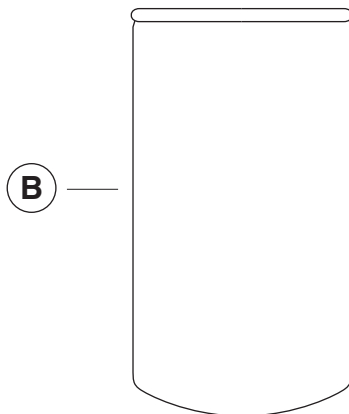
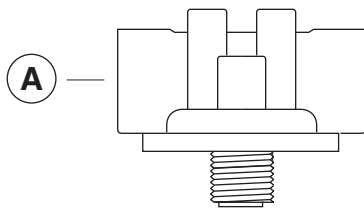

Part	Description	Part Number
A	Filter Head	See Ordering Information
B	Filter Element	See Ordering Information

Filter Head Part Number	Fluid In & Out Port Size	By-Pass Setting PSID (kPa)	Indicator Type
HH6977	1-5/16" 12 SAE	44 (303.4)	None
HH6978	1-5/16" 12 SAE	44 (303.4)	Electric*

* Electric indicator is set at 28 PSID (193.1 kPa).

Revisions

Revision	Date	Part Number
A	12-04-2017	<ul style="list-style-type: none">• Synthetic Media was FG2000™ in all locations• Created a Discontinued Section and moved in active/discontinued parts to that section.• Added Revision Section
B	07-10-2019	<ul style="list-style-type: none">• Added LT36499 to first page header, Removed 10 from side description on page 1• HF6601 B12 >75 was B11>75• Added ISO-10771-1, Removed release year and ANSI B93.25 from replacement hydraulic filter specifications• Fabrication Integrity -Added explanation to ISO 2942
C	05-14-2020	<ul style="list-style-type: none">• Formula for Flow vs Differential Pressure bottom divisor in the equation $32 \text{ mm}^2/\text{s}$ was 150